

## Cucine / Marta & Sofia



# Cucine "Marta" e "Sofia"

## Sommario / Index

Cucina "Marta"	<i>pag.</i>	1
Sottolavelli linea "Marta"	<i>pag.</i>	19
.....		
Cucina "Sofia"	<i>pag.</i>	25
Sottolavelli linea "Sofia"	<i>pag.</i>	31
.....		
Sezione tecnica "Marta"	<i>pag.</i>	50
Sezione tecnica "Sofia"	<i>pag.</i>	58
Sezione tecnica accessori	<i>pag.</i>	74

## Cucina “Marta”

Una linea sobria e minimale che si esprime attraverso la componibilità di molteplici elementi. Alla tradizionale struttura modulare della cucina si affiancano i pratici sottolavelli disponibili in diverse misure e tipologie. La cucina “Marta” è proposta in tre differenti finiture: bianco lucido e rovere sbiancato con cassa bianca; panna con cassa ciliegio.

*A sober and minimalist line expressed through the modularity of numerous elements. Along with the traditional modular structure of the kitchen, the practical sink bases are available in various sizes and types. The Marta kitchen is proposed in three different finishes: shiny white and bleached oak with white casework; cream colour with cherry casework.*





### Cucina "Marta"

Composizione in finitura bianca con la presenza di tutti gli elementi inclusi gli elettrodomestici in dotazione.

### "Marta" kitchen

Composition with white finish, with all the elements including appliances.



## "Marta" By Lmc

Funzionalità ed ergonomia sono gli elementi essenziali della cucina "Marta". Tutto è curato nei particolari e mirato ad una ottimale praticità d'uso. Un'attenzione che diventa elemento caratterizzante per una proposta di cucina dai costi fortemente contenuti. Nelle immagini di queste pagine: particolari delle strutture con dettagli degli elementi aperti. E' importante sottolineare la robustezza del piano di lavoro, nonché delle mensole, realizzate in "nobilitato" da 28 mm.

*The essential elements of the Marta kitchen are functional and ergonomic, with a particular attention to details and designed for the utmost practicality of use. This attention becomes the characterising element for a kitchen proposal that is very economical. The images on these pages: show various aspects of the structures with details of the open elements. It is important to underscore the sturdiness of the worktop, as well as shelves, made of 28 mm particle board.*



 **Elle emme Ci**  
LAVORAZIONE MOBILI COMPONENTI





Particolare del lavello Inox 18/10 a doppia vasca nella versione destra con pratico piano d'appoggio laterale.

*Detail of the 18/10 stainless steel double-basin sink in the right-hand version with practical lateral drain board.*



Cucina "Marta" in finitura Ciliegio

Composizione in finitura ciliegio con frontali e ante in cromatismo "panna".

*"Marta" kitchen in cherry finish*

*Composition in cherry finish with fronts and doors in cream colour.*



### "Marta" By Lmc

Dettagli della cucina "Marta" by LMC in finitura ciliegio. Per questa versione i frontali e le ante sono realizzate nello splendido ed elegante cromatismo "panna". Le ante e i cassetti si pregiano di una raffinata bordatura in ciliegio.

Gli elementi componibili sono i medesimi della finitura bianca lucida.

---

*Details of the Marta kitchen by LMC in the cherry finish. For this version, the fronts and doors are produced in the elegant cream colour. The modular elements are the same as those of the shiny white finish, and the measurements of the accessory units are also the same.*

In alto a destra, particolare delle mensole di spessore 3 cm. con profondità 31 cm. disponibili a metro lineare per l'inserimento in ogni tipologia di spazio. Seguono due dettagli della base da 40 cm. con anta e cassetto estraibile.

*In the top right, a detail of the shelf with thickness measuring 3 cm. with depth measuring 31 cm. available per linear metre for introduction into any type of space. Two details of the 40 cm. base with door and extractable con drawer follow.*



## "Marta" By Lmc



Prosegue il percorso nei dettagli della cucina "Marta" in finitura ciliegio. In questa pagina, in alto a sinistra, particolare del pratico carrello portaoggetti di grande utilità in cucina. Nella pagina di destra, sottolavello da 120 cm a tre sportelli con piedini regolabili in composizione con base da 80 cm. a due sportelli e due cassetti.

*More details of the Marta kitchen in the cherry finish. On this page, top left, detail of the practical trolley, extremely useful in the kitchen. On the right-hand page, 120 cm three-door sink unit with adjustable feet in the composition with the 80 cm two-door base unit and two drawers.*



Per ogni tipologia di finitura sono disponibili i piedini regolabili oltre, naturalmente, allo zoccolo in tre finiture: bianco, ciliegio e alluminio.

 **Elle emme Ci**  
LAVORAZIONE MOBILI COMPONIBILI

*The adjustable feet are available for each type of finish, naturally in addition to the kickboard in three finishes: white, cherry and aluminium.*

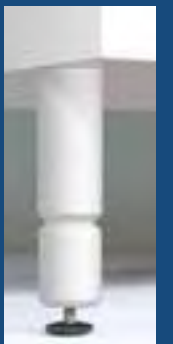



Particolare del sottolavello da 120 cm. a tre sportelli con lavello a doppia vasca sinistra e piano d'appoggio. A seguire base a 5 cassetti con piano d'appoggio.

*Detail of the 120 cm three-door sink unit with left-hand double-basin sink and drain board, along with a 5-drawer unit with work surface.*

## "Marta" By Lmc

La finitura in rovere sbiancato si pone come interessante alternativa cromatica. Una tonalità elegante che richiama al tema della cucina e del convivio. Gli elementi in appoggio a terra sono forniti di serie con i nuovi piedini regolabili in colore alluminio fermorestando, comunque, la disponibilità dei piedini optional e dello zoccolo.

*The bleached oak finish is an interesting chromatic alternative. An elegant shade that evokes the kitchen and conviviality. The elements resting on the ground are supplied with the new adjustable feet in aluminium, however, the optional feet and the base are available.*





Composizione con sottolavello e base affiancata a doppi sportelli. In soli 160 cm. una zona lavello comoda e spaziosa grazie anche ai pensili in composizione

*Composition with sink unit and base unit with double doors. In just 160 cm of space, a comfortable and spacious sink zone also thanks to the coordinated wall cupboards.*

"Marta" By Lmc

Ampi e capienti gli spazi interni per riporre, con ordine, tutta l'oggettistica tipica delle necessità in cucina.

*Large, spacious internal spaces for storing all the objects necessary for the kitchen in an orderly fashion.*



## Sottolavelli Linea "Marta"

Sink unit for "Marta" series



Una gamma di sottolavelli proposta in diversi modelli e molteplici misure, appositamente studiata per l'alloggiamento dei lavelli Inox. Sotto il profilo cromatico la linea si pregia di due finiture di ante: rovere sbiancato e bianco, predisposte per la struttura del mobile bianco, mentre, per la struttura del mobile in ciliegio, sono previste le ante in finitura panna. Molto interessanti i modelli pieghevoli che, una volta montati, sono perfettamente identici al modello fisso. Realizzati con telaio in metallo verniciato, hanno il pregio di occupare uno spazio molto ridotto in magazzino e facilitano il trasporto immediato che può essere anche carico del cliente finale, a tutto vantaggio di una vendita più veloce.

*A line of under sink cabinets proposed in different models and several dimensions, especially studied to hold stainless steel sinks. From the chromatic point of view the line offers two different possibilities of finishing for the doors: white and bleached oak for the white cabinet frame and cream-colored doors for the cherry cabinet frame. The folding models are particularly interesting: once assembled, they look exactly like the fixed models. Realised with a painted metal frame, they have the advantage of taking up very little storage space and making transport easier so clients can do it themselves, therefore speeding up the sales process.*

## Sottolavelli Linea "Marta"

Caratteristiche tecniche: Frontali in nobilitato classe E-1 spessore 18 mm. Struttura della cassa, bianca o ciliegio, in nobilitato classe E-1 spessore 18 mm. Finiture: struttura bianca per frontali bianco o rovere sbiancato; struttura ciliegio per frontale panna con bordature ciliegio delle ante.

Technical characteristics: Fronts in 18 mm thick particle board in class E-1. Structure of the casework, white or cherry, in 18 mm thick particle board in class E-1. Front finish: white or bleached oak on white structure; cream colour finish only on cherry structure.

### Sottolavello a 2 sportelli

Two-door sink unit

Sottolavello per inox

Sink unit for stainless steel sink



Struttura ciliegio con ante panna

**Elle emme Ci**  
LAVORAZIONE MOBILI COMPONENTI

### Sottolavello a 3 sportelli

Three-door sink unit

Sottolavello per inox

Sink unit for stainless steel sink



**Elle emme Ci**  
LAVORAZIONE MOBILI COMPONENTI

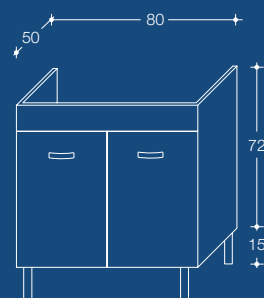

Misura disponibile  
Size available

L.80 P.50 h. 87 cm.

Finiture disponibili  
Available finishing

- Bianco (cassa bianca) con piedino bianco  
White (white casework) whit white supporting foot
- Rovere sbiancato (cassa bianca) con piedino alluminio  
bleached oak (white casework) whit aluminium supporting foot
- Panna (solo per cassa ciliegio) con piedino Ciliegio  
Cream colour (only for cherry) whit cherry supporting foot

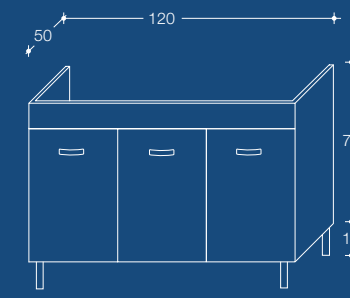

Misura disponibile  
Size available

L.120 P.50 h. 87 cm.

Finiture disponibili  
Available finishing

- Bianco (cassa bianca) con piedino bianco  
White (white casework) whit white supporting foot
- Rovere sbiancato (cassa bianca) con piedino alluminio  
bleached oak (white casework) whit aluminium supporting foot
- Panna (solo per cassa ciliegio) con piedino Ciliegio  
Cream colour (only for cherry) whit cherry supporting foot

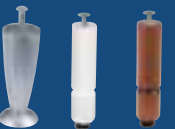

## Sottolavelli Pieghevoli *Linea "Marta"*

Caratteristiche tecniche: Frontali in nobilitato classe E-1, bianco o rovere sbiancato di spessore 18 mm. Struttura della cassa, bianca o ciliegio, in nobilitato classe E-1 spessore 18 mm. Il tutto assemblato su telaio in metallo verniciato a polveri epossidiche antiruggine e atossiche.

Technical features: Frontals in class E-1 panel boards, shiny white or bleached oak with thickness measuring 18 mm. Structure of the casework, white or cherry, in 18 mm thick particle board in class E-1. All assembled on a sheet steel frame painted with non-toxic, rust inhibitor, epoxy powder.

### Sottolavello pieghevole a 2 sportelli

Two-door folding sink unit

Sottolavello per inox

Sink unit for stainless steel sink



**Elle emme Ci**  
LAVORAZIONE MOBILI COMPONENTI

### Sottolavello pieghevole a 3 sportelli

Three-door folding sink unit

Sottolavello per inox

Sink unit for stainless steel sink



**Elle emme Ci**  
LAVORAZIONE MOBILI COMPONENTI

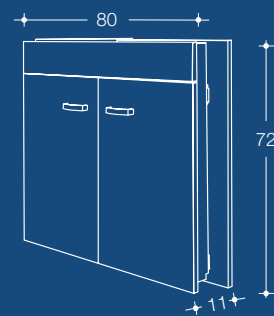

Misura disponibile  
Size available

L.80 P.50 h. 72 cm.

Finiture disponibili  
Available finishing

- Bianco (cassa bianca) con piedino bianco  
*White (white casework) whit white supporting foot*
- Rovere sbiancato (cassa bianca) con piedino alluminio  
*bleached oak (white casework) whit aluminium supporting foot*
- Panna (solo per cassa ciliegio) con piedino Ciliegio  
*Cream colour (only for cherry) whit cherry supporting foot*

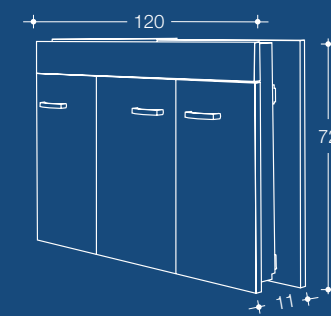

Misura disponibile  
Size available

L.120 P.50 h. 72 cm.

Finiture disponibili  
Available finishing

- Bianco (cassa bianca) con piedino bianco  
*White (white casework) whit white supporting foot*
- Rovere sbiancato (cassa bianca) con piedino alluminio  
*bleached oak (white casework) whit aluminium supporting foot*
- Panna (solo per cassa ciliegio) con piedino Ciliegio  
*Cream colour (only for cherry) whit cherry supporting foot*



Sottolavelli e complementi

## Cucina “Sofia”



Una linea di complementi per la cucina incentrata sulla disponibilità, molto ampia, di mobili sottolavelli studiati per accogliere sia i lavelli in ceramica che le versioni in Inox. Alla gamma dei sottolavelli si aggiungono le basi, i pensili e, ovviamente, si coordinano tutti gli elementi accessori inclusi gli elettrodomestici tipici per la cucina.

---

*A line of furnishing accessories for the kitchen centred on the wide availability of sink units designed to hold both the ceramic and stainless steel sinks. In addition to the range of sink units, there are the base units and wall cupboards, and naturally all the typical kitchen accessory elements are coordinated, including the appliances.*





## *"Sofia" By Lmc*

Disponibile nella finitura dei frontali e delle ante in bianco lucido e Teak, rigorosamente su cassa bianca, i complementi della serie "Sofia" si muovono in una infinità di proposte di sottolavello. In queste pagine alcuni particolari della funzionalità e della capienza oltre ad una composizione con sottolavello da 120 cm. a due ante e tre cassetti in coordinamento con base da 40 a sportello dx.

*Available with the finish of the fronts and doors in shiny white and teak, strictly on white casework, the accessory units of the Sofia kitchen can be used with an infinite variety of sink unit proposals. These pages show some particulars of the functionality and capacity along with a composition with 120 cm sink unit with two doors and three drawers coordinated with the 40 cm base with right-hand door.*



 **Elle emme Ci**  
LAVORAZIONE MOBILI COMPONIBILI



### "Sofia" By Lmc

L'intramontabile Teak rappresenta ancora un cromatismo molto richiesto. La finitura delle ante e dei frontali in coordinamento con il bianco delle casse acquista una valenza fortemente contemporanea. In queste pagine: esempio di composizione articolata su 160 cm. con sottolavello e base affiancata.

*The ever-popular teak is a colouring that is always in demand. The finish of the doors and fronts in coordination with the white of the casework creates a very contemporary look. These pages: show an example of a composition on 160 cm with sink unit and base unit.*

 **Elle emme Ci**  
LAVORAZIONE MOBILI COMPONIBILI



## Sottolavelli Linea "Sofia"

Sink unit for "Sofia" series



Una gamma di sottolavelli disponibile in diversi modelli e molteplici misure predisposti per l'alloggiamento dei lavelli in inox e in ceramica. Sono disponibili in due finiture di ante: bianco e teak su struttura bianca. Ai consueti prodotti fissi si aggiungono i modelli pieghevoli che, una volta montati, sono perfettamente identici al mobile fisso. Realizzati con telaio in metallo verniciato, hanno il pregio di occupare uno spazio molto ridotto in magazzino e facilitano il trasporto immediato che può essere anche carico del cliente finale, a tutto vantaggio di una vendita più veloce. Chiudono la gamma dei sottolavelli "Sofia" i modelli per alloggiamento lavastoviglie. Disponibili in tre differenti misure offrono l'opzione del terzo fianco da inserire nel lato dell'elettrodomestico.

*A line under sink cabinets proposed in different models and several dimensions, especially studied to hold stainless steel and ceramic sinks. We have available two kind of finish of the doors: white and teak on white structure. Other than the usual fixed products, there are also folding models, particularly interesting as they look exactly like the fixed models after assembly. Made of a painted metal frame, these have the advantage of taking up very little storage space and making transport easier so clients can do it themselves, therefore speeding up the sales process. The "Sofia" line includes base cabinets for built-in dishwashers, available in three different dimensions and with an optional side panel.*

## Sottolavelli per lavelli Inox Linea "Sofia"

Caratteristiche tecniche per i modelli fissi: frontale e sportelli bianchi o teak in nobilitato classe E-1 spessore 16 mm. Struttura bianca in nobilitato classe E-1 spessore 16 mm.

Technical characteristics for the fixed models: fronts and doors white or teak in 16 mm thick particle board class E-1. White particle board class E-1 structure 16 mm thick.

### Sottolavello a 2 sportelli

Two-door sink unit

Sottolavello per inox  
Sink unit for stainless steel sink



**Elle emme Ci**  
LAVORAZIONE MOBILI COMPONIBILI

### Sottolavello a 1 sportello e 3 cassetti

Sink unit with one door and 3 drawers

Sottolavello per inox  
Sink unit for stainless steel sink



**Elle emme Ci**  
LAVORAZIONE MOBILI COMPONIBILI

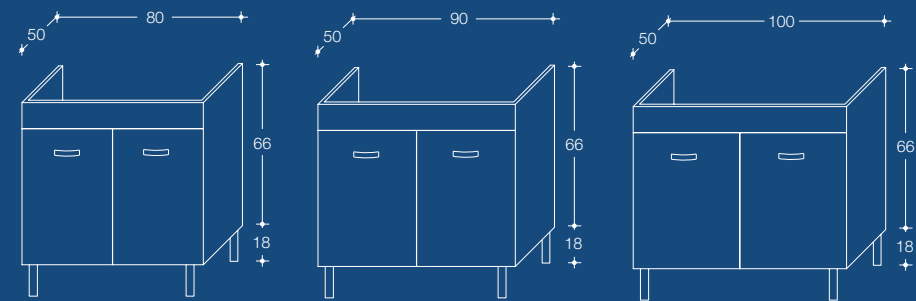

Misura disponibile  
Size available

L. 80 P. 50 h.84 cm.  
L. 90 P. 50 h.84 cm.  
L. 100 P. 50 h.84 cm.

Finiture disponibili  
Available finishing

■ Bianco con piedino bianco  
White with white supporting foot  
■ Teak con piedino Noce  
Teak with walnut supporting foot

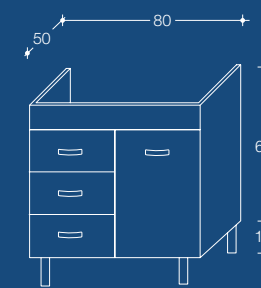
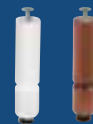

Misura disponibile  
Size available

L. 80 P. 50 h.84 cm.

Finiture disponibili  
Available finishing

■ Bianco con piedino bianco  
White with white supporting foot  
■ Teak con piedino Noce  
Teak with walnut supporting foot



## Sottolavelli per lavelli Inox *Linea "Sofia"*

Caratteristiche tecniche per i modelli fissi: frontale e sportelli bianchi o teak in nobilitato classe E-1 spessore 16 mm. Struttura bianca in nobilitato classe E-1 spessore 16 mm.

Technical characteristics for the fixed models: fronts and doors white or teak in 16 mm thick particle board class E-1. White particle board class E-1 structure 16 mm thick.

### Sottolavello a 2 sportelli e 3 cassetti

Sink unit with two door and 3 drawers

Sottolavello per inox

Sink unit for stainless steel sink



**Elle emme Ci**  
LAVORAZIONE MOBILI COMPONENTI

### Sottolavello a 3 sportelli

Three-door sink unit

Sottolavello per inox

Sink unit for stainless steel sink



**Elle emme Ci**  
LAVORAZIONE MOBILI COMPONENTI

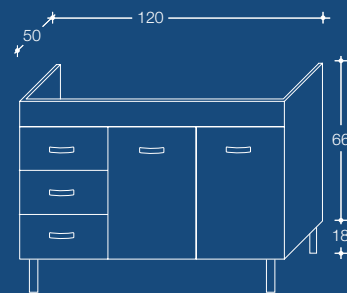

Misura disponibile  
Size available

L. 120 P. 50 h. 84 cm.

Finiture disponibili  
Available finishing

- Bianco con piedino bianco  
White Teak with white supporting foot
- Teak con piedino Noce  
Teak with walnut supporting foot

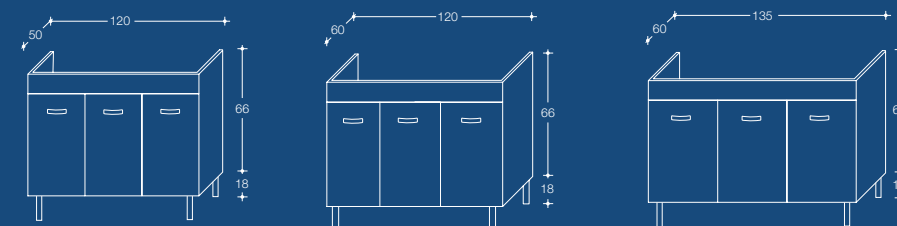

Misura disponibile  
Size available

L. 120 P. 50 h. 84 cm.  
L. 120 P. 60 h. 84 cm.  
L. 135 P. 60 h. 84 cm.

Finiture disponibili  
Available finishing

- Bianco con piedino bianco  
White Teak with white supporting foot
- Teak con piedino Noce  
Teak with walnut supporting foot



## Sottolavelli Pieghevoli per Inox Linea "Sofia"

Caratteristiche tecniche: Frontali e sportelli bianchi o teak in nobilitato classe E-1 di spessore 16 mm. Struttura bianca in nobilitato classe E-1 spessore 16 mm. Il tutto assemblato su telaio in metallo verniciato a polveri epossidiche antruggine e atossiche

Technical features: Frontals and doors white or teak in class E-1 panel boards with thickness measuring 18 mm. White particle board class E-1 structure 16 mm thick. All assembled on a sheet steel frame painted with non-toxic, rust inhibitor, epoxy powder.

### Sottolavello pieghevole a 2 sportelli

Two-door folding sink unit

Sottolavello per inox

Sink unit for stainless steel sink



**Elle emme Ci**  
LAVORAZIONE MOBILI COMPONENTI

### Sottolavello pieghevole a 3 sportelli

Three-door folding sink unit

Sottolavello per inox

Sink unit for stainless steel sink



**Elle emme Ci**  
LAVORAZIONE MOBILI COMPONENTI

#### Misura disponibile

Size available

- L. 80 P. 50 h. 66 cm.
- L. 90 P. 50 h. 66 cm.
- L. 100 P. 50 h. 66 cm.

#### Finiture disponibili

Available finishing

- Bianco con piedino bianco  
White with white supporting foot
- Teak con piedino Noce  
Teak with walnut supporting foot

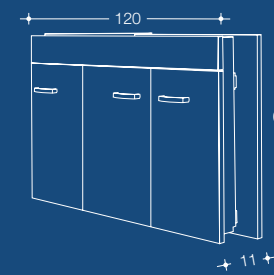
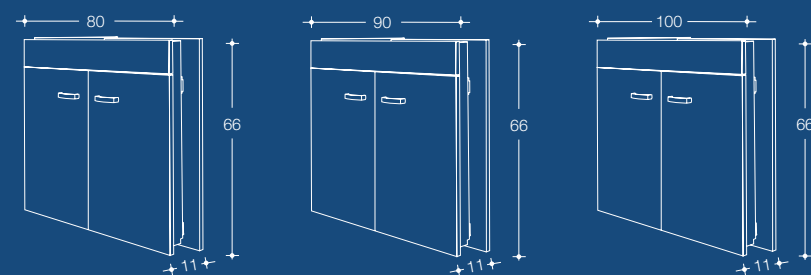

#### Misura disponibile

Size available

- L. 120 P. 50 h. 66 cm.

#### Finiture disponibili

Available finishing

- Bianco con piedino bianco  
White with white supporting foot
- Teak con piedino Noce  
Teak with walnut supporting foot



# Sottolavelli per ceramica Linea "Sofia"

Caratteristiche tecniche per i modelli fissi: frontale e sportelli bianchi o teak in nobilitato classe E-1 spessore 16 mm. Struttura bianca in nobilitato classe E-1 spessore 16 mm.

Technical characteristics for the fixed models: fronts and doors in white or teak 16 mm thick particle board class E-1. White particle board class E-1 structure 16 mm thick.

## Sottolavello a 2 sportelli

Two-door sink unit

Sottolavello per ceramica  
Sink unit for ceramic sink



**Elle emme Ci**  
LAVORAZIONE MOBILI COMPONENTI

## Sottolavello a 1 sportello e 3 cassetti

Sink unit with one door and 3 drawers

Sottolavello per ceramica  
Sink unit for ceramic sink



**Elle emme Ci**  
LAVORAZIONE MOBILI COMPONENTI

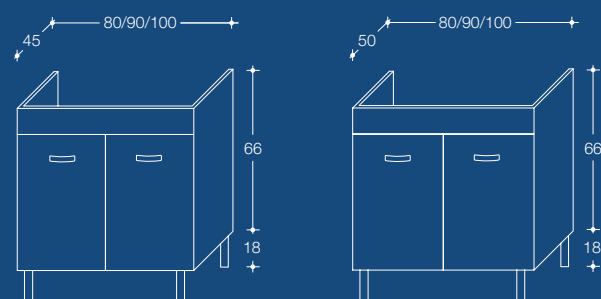

Misure disponibili P. 45  
Size available P. 45

- L. 80 P. 45 h.84 cm.
- L. 90 P. 45 h.84 cm.
- L. 100 P. 45 h.84 cm.

Misure disponibili P. 50  
Size available P. 50

- L. 80 P. 50 h.84 cm.
- L. 90 P. 50 h.84 cm.
- L. 100 P. 50 h.84 cm.

Finiture disponibili  
Available finishing

- Bianco con piedino bianco  
White with white supporting foot
- Teak con piedino Noce  
Teak with walnut supporting foot

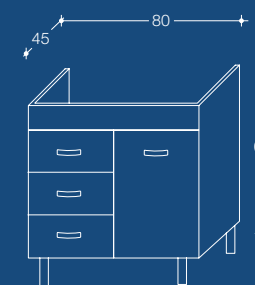
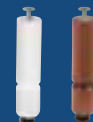

Misura disponibile  
Size available

- L. 80 P. 45 h.84 cm.

Finiture disponibili  
Available finishing

- Bianco con piedino bianco  
White with white supporting foot
- Teak con piedino Noce  
Teak with walnut supporting foot



## Sottolavelli per ceramica Linea "Sofia"

Caratteristiche tecniche per i modelli fissi: frontale e sportelli bianchi o teak in nobilitato classe E-1 spessore 16 mm. Struttura bianca in nobilitato classe E-1 spessore 16 mm.

Technical characteristics for the fixed models: fronts and doors in white or teak 16 mm thick particle board class E-1. White particle board class E-1 structure 16 mm thick.

### Sottolavello a 2 sportelli e 3 cassetti

Sink unit with two door and 3 drawers

Sottolavello per ceramica  
Sink unit for ceramic sink



**Elle emme Ci**  
LAVORAZIONE MOBILI COMPONENTI

### Sottolavello a 3 sportelli

Sink unit with 3 drawers

Sottolavello per ceramica  
Sink unit for ceramic sink



**Elle emme Ci**  
LAVORAZIONE MOBILI COMPONENTI

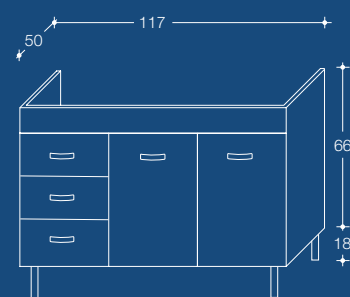

Misura disponibile  
Size available

L. 117 P. 50 h. 84 cm.

Finiture disponibili  
Available finishing

- Bianco con piedino bianco  
White with white supporting foot
- Teak con piedino Noce  
Teak with walnut supporting foot

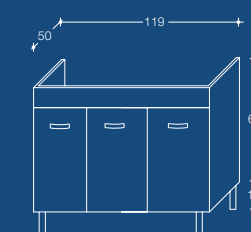
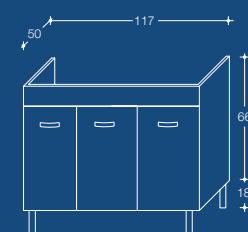
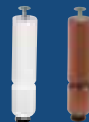

(per lavello "Galassia")  
(for "Galassia" sink)

Misura disponibile  
Size available

L. 117 P. 50 h. 84 cm.  
L. 119 P. 50 h. 84 cm.

Finiture disponibili  
Available finishing

- Bianco con piedino bianco  
White with white supporting foot
- Teak con piedino Noce  
Teak with walnut supporting foot



## Sottolavelli Pieghevoli per ceramica Linea "Sofia"

Caratteristiche tecniche: Frontali e sportelli bianchi o teak in nobilitato classe E-1 di spessore 16 mm. Struttura bianca in nobilitato classe E-1 spessore 16 mm. Il tutto assemblato su telaio in metallo verniciato a polveri epossidiche antruggine e atossiche

Technical features: Frontals and doors white or teak in class E-1 panel boards, with thickness measuring 16 mm. White particle board class E-1 structure 16 mm thick. All assembled on a sheet steel frame painted with non-toxic, rust inhibitor, epoxy powder.

### Sottolavello pieghevole a 2 sportelli

Two-door folding sink unit

Sottolavello per ceramica  
Sink unit for ceramic sink



**Elle emme Ci**  
LAVORAZIONE MOBILI COMPONIBILI

### Sottolavello pieghevole a 3 sportelli

Three-door folding sink unit

Sottolavello per ceramica  
Sink unit for ceramic sink



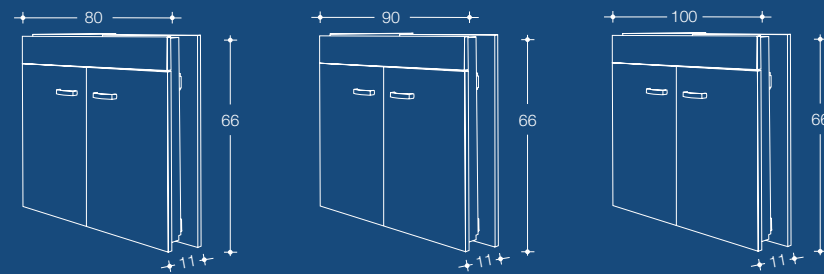

**Elle emme Ci**  
LAVORAZIONE MOBILI COMPONIBILI



Misura disponibile  
Size available

L. 80 P. 45 h. 66 cm.  
L. 90 P. 45 h. 66 cm.  
L. 100 P. 45 h. 66 cm.

Finiture disponibili  
Available finishing

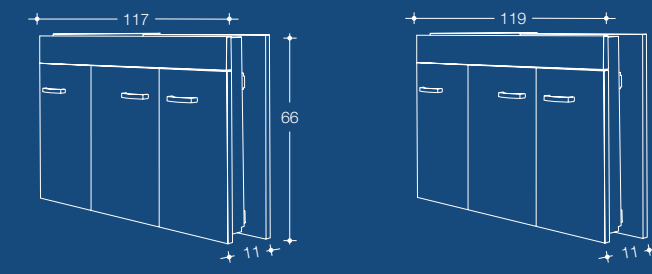
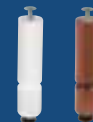

 Bianco con piedino bianco  
White with white supporting foot  
 Teak con piedino Noce  
Teak with walnut supporting foot



Misura disponibile  
Size available

L. 117 P. 50 h. 66 cm.  
L. 119 P. 50 h. 66 cm. (Ceramica Galassia)

Finiture disponibili  
Available finishing

 Bianco con piedino bianco  
White with white supporting foot  
 Teak con piedino Noce  
Teak with walnut supporting foot



## Sottolavelli per Incasso Lavastoviglie

Caratteristiche tecniche: frontale e ante bianche o teak in nobilitato classe E-1 spessore 16 mm. Struttura ed eventuale 3° fianco, a chiusura laterale dell' elettrodomestico, dx o sx solo in nobilitato bianco classe E-1 di spessore 16 mm.

Technical features: white or teak frontal and doors in class E-1 particle board with thickness measuring 16 mm. Structure and eventual 3rd side, with right or left lateral enclosure of the household appliance, in class E-1 particle board with thickness measuring 16 mm.

### Sottolavello per lavastoviglie a 1 sportello

Sink unit for dishwasher with one door

Sottolavello per inox

Sink unit for stainless steel sink



**Elle emme Ci**  
LAVORAZIONE MOBILI COMPONIBILI

### Sottolavello per lavastoviglie a 2 sportelli

Sink unit for dishwasher with two door

Sottolavello per inox

Sink unit for stainless steel sink



**Elle emme Ci**  
LAVORAZIONE MOBILI COMPONIBILI

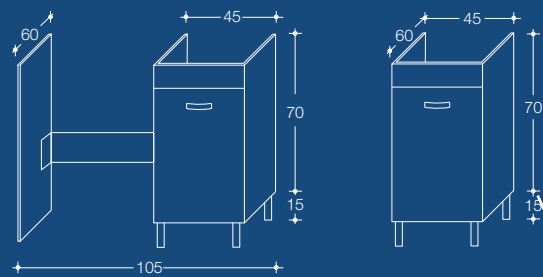

Misura disponibile  
Size available

L. 45 P. 60 h.85 cm.

Modello Con 3° fianco  
Third side model

L. 105 P. 60 h.85 cm.

Finiture disponibili  
Available finishing

 Bianco con piedino bianco  
White with white supporting foot

 Teak con piedino Noce  
Teak with walnut supporting foot

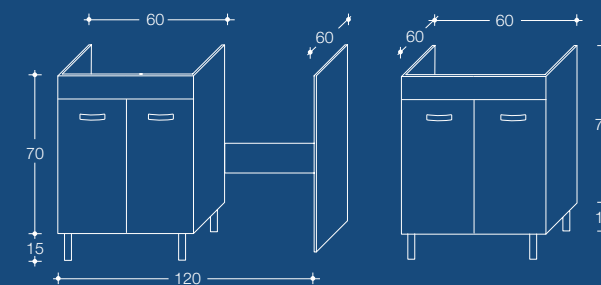

Misura disponibile  
Size available

L. 60 P. 60 h.85 cm.

Modello Con 3° fianco  
Third side model

L. 120 P. 60 h.85 cm.

Finiture disponibili  
Available finishing

 Bianco con piedino bianco  
White with white supporting foot

 Teak con piedino Noce  
Teak with walnut supporting foot



## Sottolavelli per Incasso Lavastoviglie

Caratteristiche tecniche: frontale e ante bianche o teak in nobilitato classe E-1 spessore 16 mm. Struttura ed eventuale 3° fianco, a chiusura laterale dell' elettrodomestico, dx o sx solo in nobilitato bianco classe E-1 di spessore 16 mm.

Technical features: white or teak frontal and doors in class E-1 particle board with thickness measuring 16 mm. Structure and eventual 3rd side, with right or left lateral enclosure of the household appliance, in class E-1 particle board with thickness measuring 16 mm.

### Sottolavello per lavastoviglie a 2 sportelli

Sink unit for dishwasher with two door

### Sottolavello per inox

Sink unit for stainless steel sink



**Elle emme Ci**  
LAVORAZIONE MOBILI COMPONIBILI

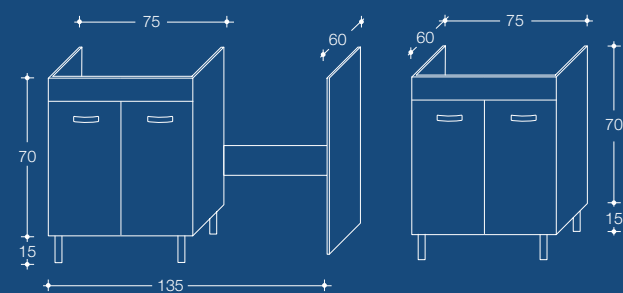

Misura disponibile  
Misura disponibile

L. 75 P. 60 h.85 cm.

Modello Con 3° fianco  
Third side model

L. 135 P. 60 h.85 cm.

Finiture disponibili  
Available finishing

■ Bianco con piedino bianco  
White with white supporting foot

■ Teak con piedino Noce  
Teak with walnut supporting foot



## Riepilogo dei lavelli Inox per cucine "Marta" e "Sofia"

Summary of the stainless steel sinks for "Marta" and "Sofia" kitchens

Realizzati in acciaio Inox 18/10 sono forniti completi di sifone, piletta e troppo pieno, oltre al tappo copriforo per eventuale predisposizione delle rubinetterie a muro.

Realised in stainless steel 18/10 and supplied complete with siphon, drain connection and overflow, as well as the hole cover for eventual preparation of wall-mounted fittings.

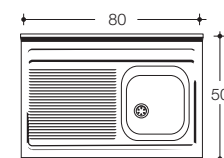

**Cod 04000 (D/S)**  
80x50 cm. una vasca dx/sx  
con piano laterale

80x50 cm. one basin right/left  
with drain board

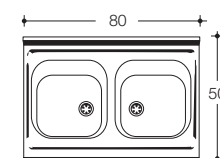

**Cod 04004**  
80x50 cm. due vasche

80x50 cm. two basins

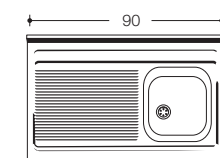

**Cod 04001 (D/S)**  
90x50 cm. una vasca dx/sx  
con piano laterale

90x50 cm. one basin right/left  
with drain board

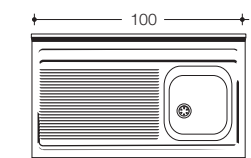

**Cod 04002 (D/S)**  
100x50 cm. una vasca dx/sx  
con piano laterale

100x50 cm. one basin right/left  
with drain board

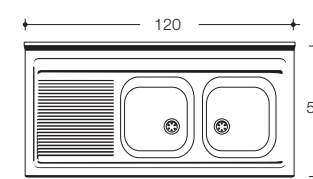

**Cod 04003 (D/S)**  
120x50 cm. due vasche dx/sx  
con piano laterale

120x50 cm. two basins right/left  
with drain board

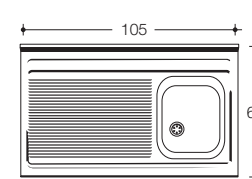

**Cod 04009 (D/S)**  
105x60 cm. una vasca dx/sx  
con piano laterale

105x60 cm. one basins  
right/left with drain board

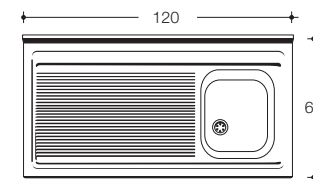

**Cod 04010 (D/S)**  
120x60 cm. una vasca dx/sx  
con piano laterale

120x60 cm. one basins  
right/left with drain board

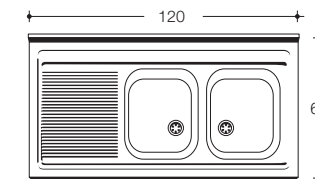

**Cod 04012 (D/S)**  
120x60 cm. due vasche dx/sx  
con piano laterale

120x60 cm. two basins right/left  
with drain board

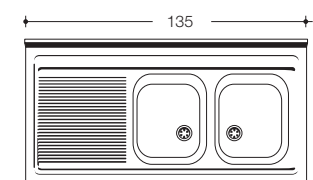

**Cod 04011 (D/S)**  
135x60 cm. due vasche dx/sx  
con piano laterale

135x60 cm. two basins  
right/left with drain board

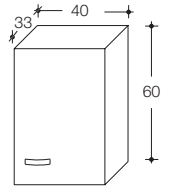
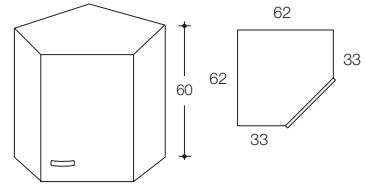
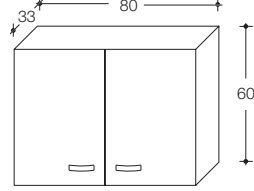
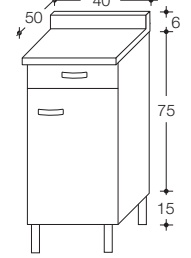
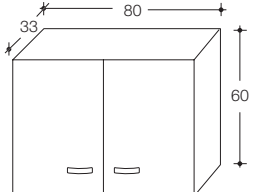
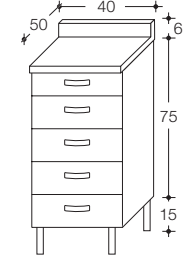
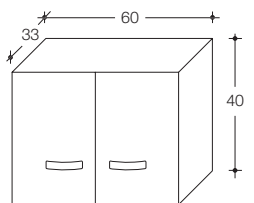
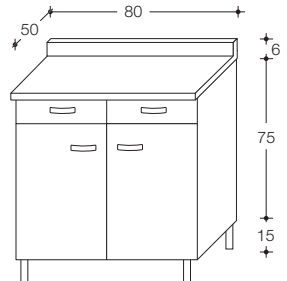
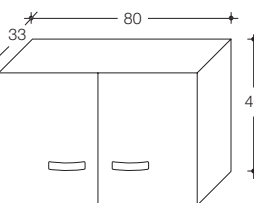
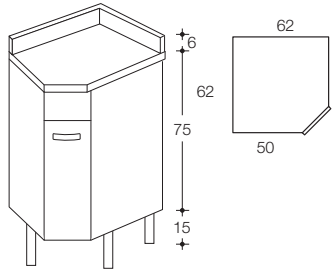
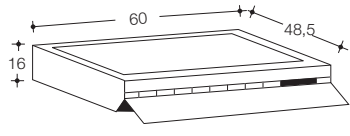
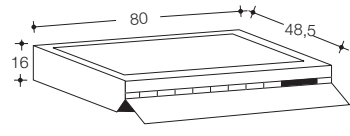
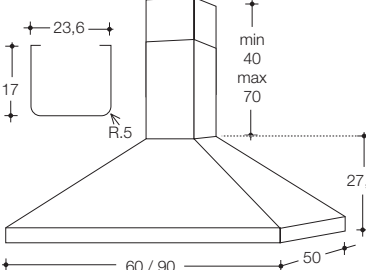

ELEMENTO / ELEMENT	CODICE / CODE	DESCRIZIONE / DESCRIPTION	MISURE / DIMENSIONS	FINITURE ANTE / DOORS FINISH	ELEMENT / ELEMENTO	CODICE / CODE	DESCRIZIONE / DESCRIPTION	MISURE / DIMENSIONS	FINITURE ANTE / DOORS FINISH
	Art. 15000 /D Art. 15001 /D Art. 15002 /D	Pensile con anta, apertura lato dx. <i>Overhead cupboard with door, opening on right hand side.</i>	40 x 33 x h.60 cm.	<input type="checkbox"/> Bianco (cassa bianca) <i>White (white casework)</i> <input type="checkbox"/> Panna (cassa ciliegio) <i>Cream colour (only for cherry)</i> <input type="checkbox"/> Rovere sbiancato (cassa bianca) <i>bleached oak (white casework)</i>		Art. 15021 Art. 15022 Art. 15023	Pensile angolo con anta ad apertura lato destro. <i>Corner overhead cupboard with door, opening on right hand side.</i>	62 x 62 x P. 33 x h.60 cm.	<input type="checkbox"/> Bianco (cassa bianca) <i>White (white casework)</i> <input type="checkbox"/> Panna (cassa ciliegio) <i>Cream colour (only for cherry)</i> <input type="checkbox"/> Rovere sbiancato (cassa bianca) <i>bleached oak (white casework)</i>
	Art. 15003 Art. 15004 Art. 15005	Pensile, apertura a 2 ante. <i>Storage overhead cupboard, with opening doors.</i>	80 x 33 x h.60cm.	<input type="checkbox"/> Bianco (cassa bianca) <i>White (white casework)</i> <input type="checkbox"/> Panna (cassa ciliegio) <i>Cream colour (only for cherry)</i> <input type="checkbox"/> Rovere sbiancato (cassa bianca) <i>bleached oak (white casework)</i>		Art. 15024/D Art. 15025/D Art. 15026/D	Base con anta ad apertura destra e un cassetto. <i>Base with door opening on right hand side and one drawer.</i>	40 x 50 x h.96 cm.	<input type="checkbox"/> Bianco (cassa bianca) <i>White (white casework)</i> <input type="checkbox"/> Panna (cassa ciliegio) <i>Cream colour (only for cherry)</i> <input type="checkbox"/> Rovere sbiancato (cassa bianca) <i>bleached oak (white casework)</i>
	Art. 15006 Art. 15007 Art. 15008	Pensile scolapiatti, apertura a 2 ante. <i>Dish draining cupboard, with two opening doors.</i>	80 x 33 x h.60cm.	<input type="checkbox"/> Bianco (cassa bianca) <i>White (white casework)</i> <input type="checkbox"/> Panna (cassa ciliegio) <i>Cream colour (only for cherry)</i> <input type="checkbox"/> Rovere sbiancato (cassa bianca) <i>bleached oak (white casework)</i>		Art. 15027 Art. 15028 Art. 15029	Base con cinque cassetti. <i>Base with five drawers.</i>	40 x 50 x h.96 cm.	<input type="checkbox"/> Bianco (cassa bianca) <i>White (white casework)</i> <input type="checkbox"/> Panna (cassa ciliegio) <i>Cream colour (only for cherry)</i> <input type="checkbox"/> Rovere sbiancato (cassa bianca) <i>bleached oak (white casework)</i>
	Art. 15015 Art. 15016 Art. 15017	Pensile sopra cappa, apertura a 2 ante. <i>Overhead stove ventilation hood, with two opening doors.</i>	60 x 33 x h.40 cm.	<input type="checkbox"/> Bianco (cassa bianca) <i>White (white casework)</i> <input type="checkbox"/> Panna (cassa ciliegio) <i>Cream colour (only for cherry)</i> <input type="checkbox"/> Rovere sbiancato (cassa bianca) <i>bleached oak (white casework)</i>		Art. 15030 Art. 15031 Art. 15032	Base con apertura a 2 ante e due cassetti. <i>Base with two opening doors and two drawers.</i>	80 x 50 x h.96 cm.	<input type="checkbox"/> Bianco (cassa bianca) <i>White (white casework)</i> <input type="checkbox"/> Panna (cassa ciliegio) <i>Cream colour (only for cherry)</i> <input type="checkbox"/> Rovere sbiancato (cassa bianca) <i>bleached oak (white casework)</i>
	Art. 15018 Art. 15019 Art. 15020	Pensile sopra cappa, apertura a 2 ante. <i>Overhead stove ventilation hood, with two opening doors.</i>	80 x 33 x h.40 cm.	<input type="checkbox"/> Bianco (cassa bianca) <i>White (white casework)</i> <input type="checkbox"/> Panna (cassa ciliegio) <i>Cream colour (only for cherry)</i> <input type="checkbox"/> Rovere sbiancato (cassa bianca) <i>bleached oak (white casework)</i>		Art. 15033 Art. 15034 Art. 15035	Base angolo, anta ad apertura lato destro. <i>Corner base with door opening on right hand side.</i>	62 x 62 x P. 50 x h.96 cm.	<input type="checkbox"/> Bianco (cassa bianca) <i>White (white casework)</i> <input type="checkbox"/> Panna (cassa ciliegio) <i>Cream colour (only for cherry)</i> <input type="checkbox"/> Rovere sbiancato (cassa bianca) <i>bleached oak (white casework)</i>
	Art. 19008 /B Art. 19008 /N	Gruppo filtrante per cappa. <i>Filtering unit for hood.</i>	60 x 48,5 xh. 16 cm	<input type="checkbox"/> Bianco <i>White</i> <input type="checkbox"/> Nero <i>Black</i>					
	Art. 19009 /B Art. 19009 /N	Gruppo filtrante per cappa. <i>Filtering unit for hood.</i>	80 x 48,5 xh. 16 cm.	<input type="checkbox"/> Bianco <i>White</i> <input type="checkbox"/> Nero <i>Black</i>					
	Art. 19045 Art. 19046	Cappa camino filtrante in acciaio inox. <i>Stainless steel ventilation chute hood.</i>	60 x 50 x h.67,5/97,5 cm. 90 x 50 x h.67,5/97,5 cm.						

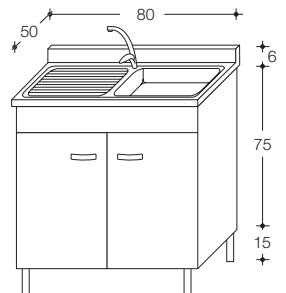
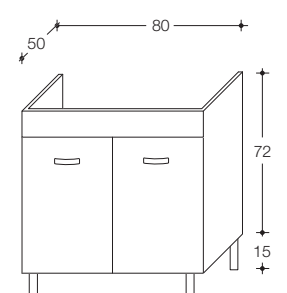
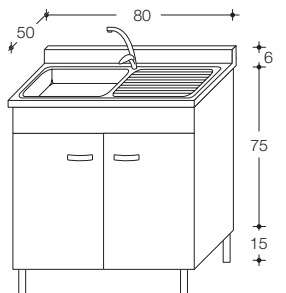
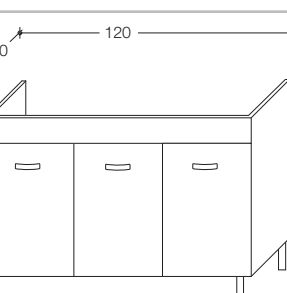
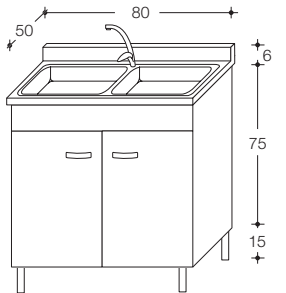
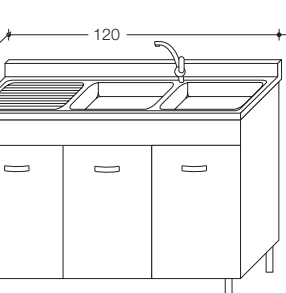
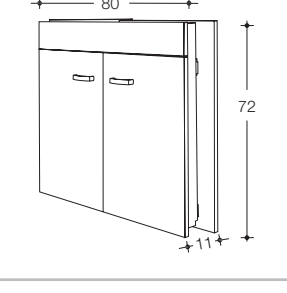
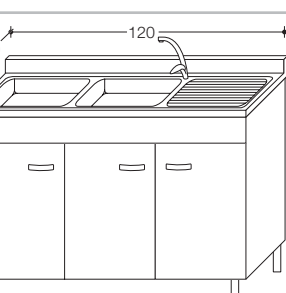
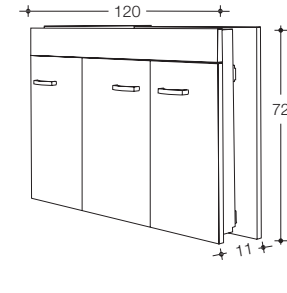
ELEMENTO / ELEMENT	CODICE / CODE	DESCRIZIONE / DESCRIPTION	MISURE / DIMENSIONS	FINITURE ANTE / DOORS FINISH	ELEMENTO / ELEMENT	CODICE / CODE	DESCRIZIONE / DESCRIPTION	MISURE / DIMENSIONS	FINITURE ANTE / DOORS FINISH					
	Art. 15048/D Art. 15049/D Art. 15050/D	Sottolavello con struttura fissa completo di lavello in acciaio inox con vasca destra. <i>Under-sink bench with fixed structure, complete with single right stainless steel sink.</i>	80 x 50 x h.96 cm.	<input type="checkbox"/> Bianco (cassa bianca) <i>White (white casework)</i> <input type="checkbox"/> Panna (cassa ciliegio) <i>Cream colour (only for cherry)</i> <input type="checkbox"/> Rovere sbiancato (cassa bianca) <i>bleached oak (white casework)</i>		Art. 15036 Art. 15037 Art. 15038	Sottolavello a due ante, con struttura fissa, solo per lavello in acciaio inox. <i>Under-sink bench with two doors, fixed structure, only for stainless steel sinks.</i>	80 x 50 x h.87 cm.	<input type="checkbox"/> Bianco (cassa bianca) <i>White (white casework)</i> <input type="checkbox"/> Panna (cassa ciliegio) <i>Cream colour (only for cherry)</i> <input type="checkbox"/> Rovere sbiancato (cassa bianca) <i>bleached oak (white casework)</i>					
	Art. 15048/S Art. 15049/S Art. 15050/S	Sottolavello con struttura fissa completo di lavello in acciaio inox con vasca sinistra. <i>Under-sink bench with fixed structure, complete with single left stainless steel sink.</i>	80 x 50 x h.96 cm.	<input type="checkbox"/> Bianco (cassa bianca) <i>White (white casework)</i> <input type="checkbox"/> Panna (cassa ciliegio) <i>Cream colour (only for cherry)</i> <input type="checkbox"/> Rovere sbiancato (cassa bianca) <i>bleached oak (white casework)</i>		Art. 15039 Art. 15040 Art. 15041	Sottolavello a tre ante con struttura fissa, solo per lavello in acciaio inox. <i>Under-sink bench with three doors and fixed structure, only for stainless steel sinks.</i>	120 x 50 x h.87 cm.	<input type="checkbox"/> Bianco (cassa bianca) <i>White (white casework)</i> <input type="checkbox"/> Panna (cassa ciliegio) <i>Cream colour (only for cherry)</i> <input type="checkbox"/> Rovere sbiancato (cassa bianca) <i>bleached oak (white casework)</i>					
	Art. 15051 Art. 15052 Art. 15053	Sottolavello con struttura fissa completo di lavello in acciaio inox con 2 vasche. <i>Under-sink bench with fixed structure, complete with double stainless steel sink.</i>	80 x 50 x h.96 cm.	<input type="checkbox"/> Bianco (cassa bianca) <i>White (white casework)</i> <input type="checkbox"/> Panna (cassa ciliegio) <i>Cream colour (only for cherry)</i> <input type="checkbox"/> Rovere sbiancato (cassa bianca) <i>bleached oak (white casework)</i>	<b>Sottolavelli pieghevoli predisposti per lavello inox</b> <i>Under sink cabinets with folding structure prepared for stainless steel sink</i>					<b>Cucina "MARTA"</b>				
	Art. 15054/D Art. 15055/D Art. 15056/D	Sottolavello con struttura fissa completo di lavello in acciaio inox con 2 vasche destre. <i>Under-sink bench with fixed structure, complete with double right stainless steel sink.</i>	120 x 50 x h.96 cm.	<input type="checkbox"/> Bianco (cassa bianca) <i>White (white casework)</i> <input type="checkbox"/> Panna (cassa ciliegio) <i>Cream colour (only for cherry)</i> <input type="checkbox"/> Rovere sbiancato (cassa bianca) <i>bleached oak (white casework)</i>		Art. 15042 Art. 15043 Art. 15044	Sottolavello a 2 ante pieghevole con struttura assemblata su telaio in metallo a piega nascosta, solo per lavello in acciaio inox. <i>Under sink cabinet with 2 folding doors with structure assembled on hidden bend metal frame, only for stainless steel sinks.</i>	80 x 50 x h.72 cm.	<input type="checkbox"/> Bianco (cassa bianca) <i>White (white casework)</i> <input type="checkbox"/> Panna (cassa ciliegio) <i>Cream colour (only for cherry)</i> <input type="checkbox"/> Rovere sbiancato (cassa bianca) <i>bleached oak (white casework)</i>					
	Art. 15054/S Art. 15055/S Art. 15056/S	Sottolavello con struttura fissa completo di lavello in acciaio inox con 2 vasche sinistre. <i>Under-sink bench with fixed structure, complete with double left stainless steel sink.</i>	120 x 50 x h.96 cm.	<input type="checkbox"/> Bianco (cassa bianca) <i>White (white casework)</i> <input type="checkbox"/> Panna (cassa ciliegio) <i>Cream colour (only for cherry)</i> <input type="checkbox"/> Rovere sbiancato (cassa bianca) <i>bleached oak (white casework)</i>		Art. 15045 Art. 15046 Art. 15047	Sottolavello a 3 ante pieghevole con struttura assemblata su telaio in metallo a piega nascosta, solo per lavello in acciaio inox. <i>Under sink cabinet with 3 folding doors with structure assembled on hidden bend metal frame, only for stainless steel sinks.</i>	120 x 50 x h.72 cm.	<input type="checkbox"/> Bianco (cassa bianca) <i>White (white casework)</i> <input type="checkbox"/> Panna (cassa ciliegio) <i>Cream colour (only for cherry)</i> <input type="checkbox"/> Rovere sbiancato (cassa bianca) <i>bleached oak (white casework)</i>					

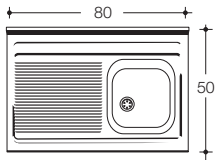
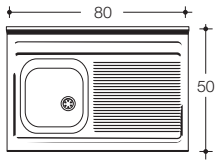
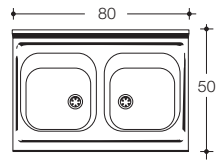
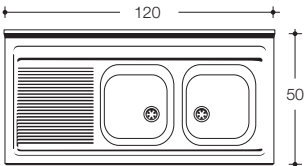
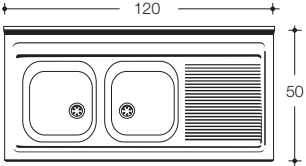
ELEMENTO / ELEMENT	CODICE / CODE	DESCRIZIONE / DESCRIPTION	MISURE / DIMENSIONS	FINITURE ANTE / DOORS FINISH
	Art. 04000/D	Lavello in acciaio inox ad una vasca destra. <i>Single stainless steel right or left sink.</i>	80 x 50 x h.3 cm.	
	Art. 04000/S	Lavello in acciaio inox ad una vasca, sinistra. <i>Single stainless steel right or left sink.</i>	80 x 50 x h.3 cm.	
	Art. 04004	Lavello in acciaio inox a due vasche. <i>Double stainless steel sink.</i>	80 x 50 x h.3 cm.	
	Art. 04003/D	Lavello in acciaio inox a due vasche destre. <i>Double right stainless steel sink.</i>	120 x 50 x h.3 cm.	
	Art. 04003/S	Lavello in acciaio inox a due vasche sinistre. <i>Double left stainless steel sink.</i>	120 x 50 x h.3 cm.	











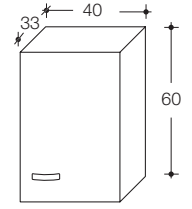

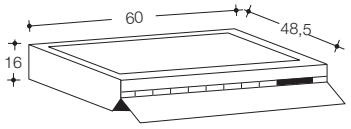

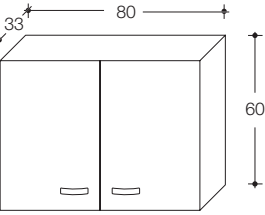

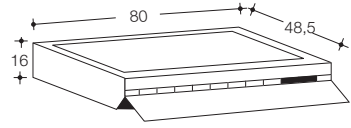

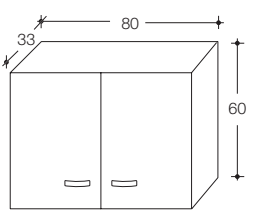

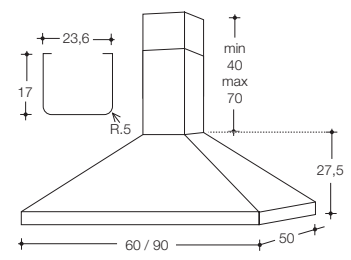

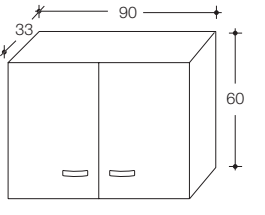

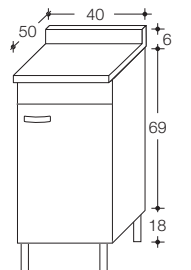
Realizzati in acciaio Inox 18/10 sono forniti completi di sifone, piletta e troppo pieno, oltre al tappo copriforo per eventuale predisposizione delle rubinetterie a muro.

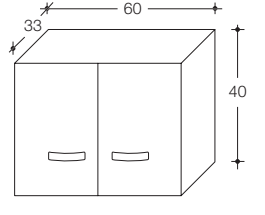

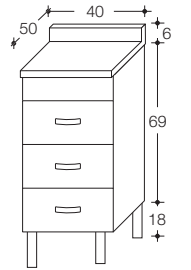

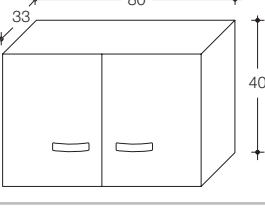

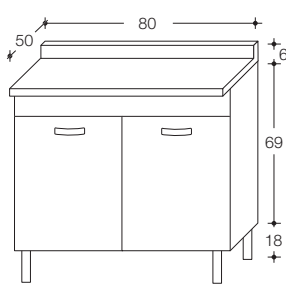



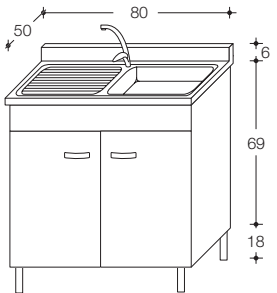

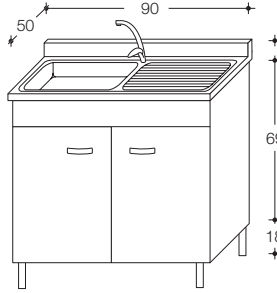

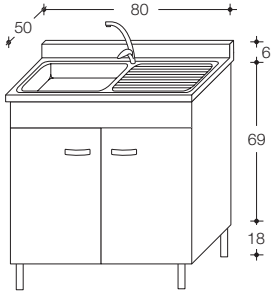

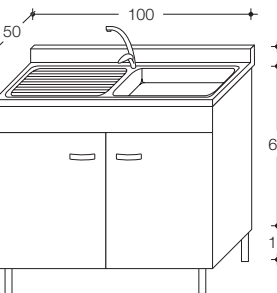

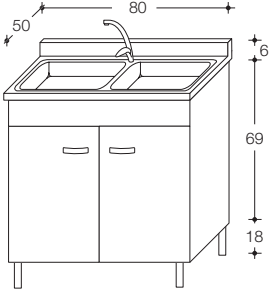

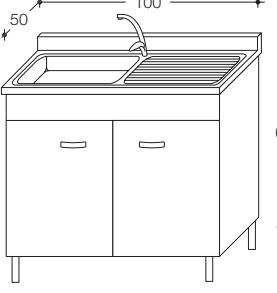

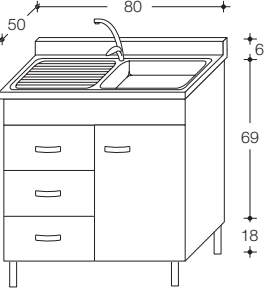

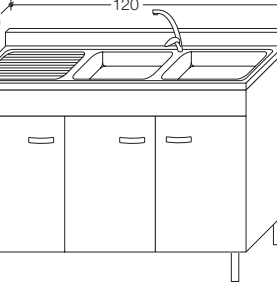
Realised in stainless steel 18/10 and supplied complete with siphon, drain connection and overflow, as well as the hole cover for eventual preparation of wall-mounted fittings.

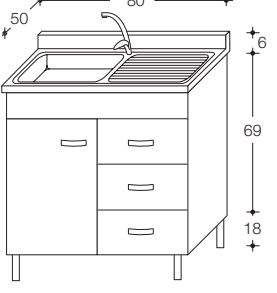

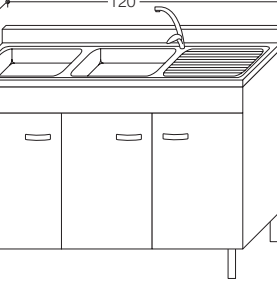

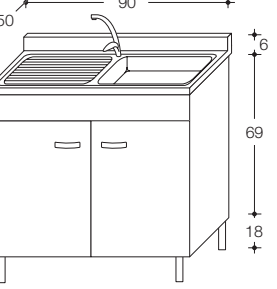

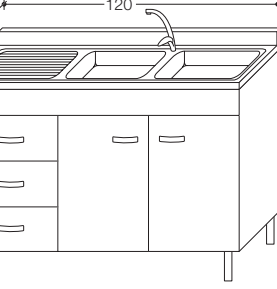



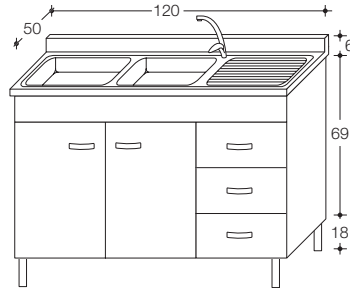

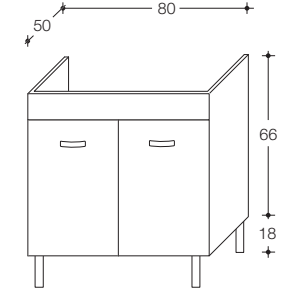

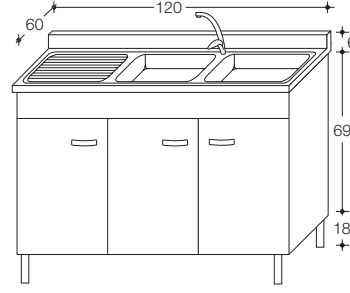

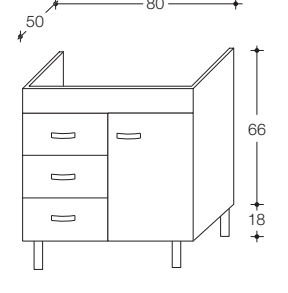

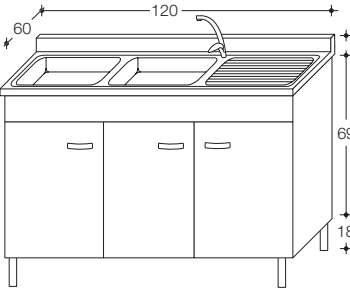

 **Elle emme Ci**  
LAVORAZIONE MOBILI COMPONIBILI

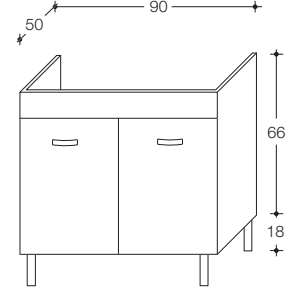

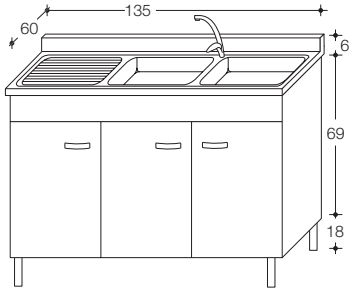

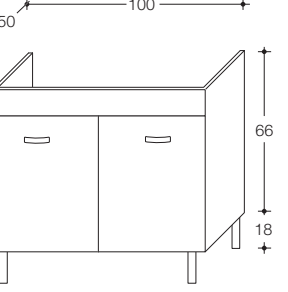

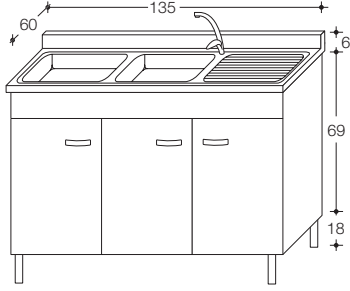



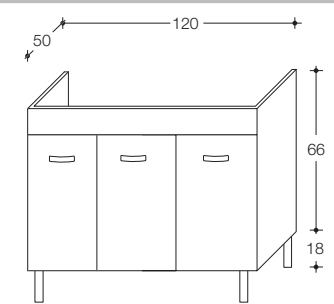

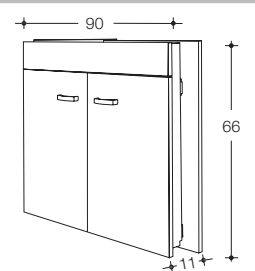

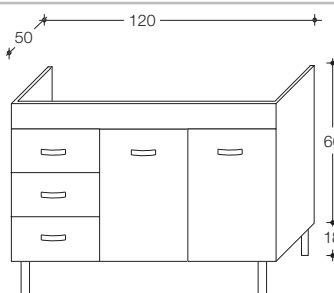



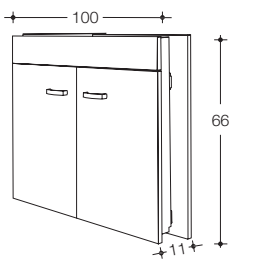

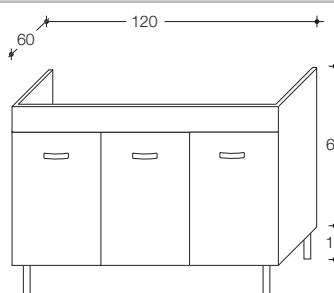

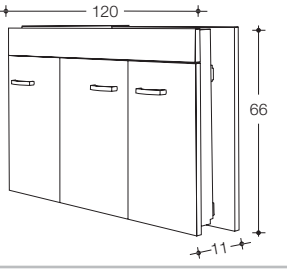

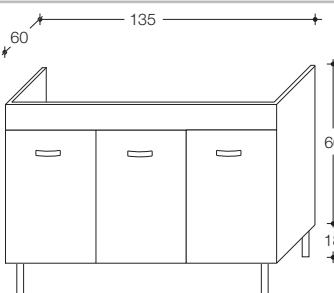

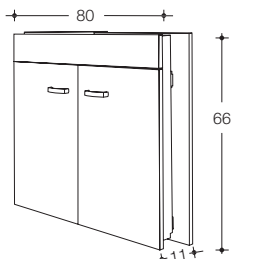

ELEMENTO / ELEMENT	CODICE / CODE	DESCRIZIONE / DESCRIPTION	MISURE / DIMENSIONS	FINITURE ANTE / DOORS FINISH	ELEMENTO / ELEMENT	CODICE / CODE	DESCRIZIONE / DESCRIPTION	MISURE / DIMENSIONS	FINITURE ANTE / DOORS FINISH
	Art. 09000/D Art. 09001/D	Pensile con anta, apertura lato dx. <i>Overhead cupboard with door, opening on right hand side.</i>	40 x 33 x h.60 cm.	 Bianco <i>White</i>  Teak <i>Teak</i>		Art. 19008/B Art. 19008/N	Gruppo filtrante per cappa. <i>Filtering unit for hood.</i>	60 x 48,5 x h.16 cm.	 Bianco <i>White</i>  Nero <i>Black</i>
	Art. 09002 Art. 09003	Pensile, apertura a 2 ante. <i>Storage overhead cupboard, with two opening doors.</i>	80 x 33 x h.60 cm.	 Bianco <i>White</i>  Teak <i>Teak</i>		Art. 19009/B Art. 19009/N	Gruppo filtrante per cappa. <i>Filtering unit for hood.</i>	80 x 48,5 x h.16 cm.	 Bianco <i>White</i>  Nero <i>Black</i>
	Art. 09004 Art. 09005	Pensile scolapiatti, apertura a 2 ante. <i>Dish draining cupboard, with two opening doors.</i>	80 x 33 x h.60 cm.	 Bianco <i>White</i>  Teak <i>Teak</i>		Art. 19045 Art. 19046	Cappa camino filtrante in acciaio inox. <i>Stainless steel ventilation chute hood.</i>	60 x 50 x h. da 67,5 a 97,5 cm. 90 x 50 x h. da 67,5 a 97,5 cm.	 Bianco <i>White</i>  Teak <i>Teak</i>
	Art. 09006 Art. 09007	Pensile scolapiatti, apertura a 2 ante. <i>Dish draining cupboard, with two opening doors.</i>	90 x 33 x h.60 cm.	 Bianco <i>White</i>  Teak <i>Teak</i>		Art. 09016/D Art. 09017/D	Base ad una anta con apertura lato destro. <i>Base with one door opening on the right hand side.</i>	40 x 50 x h.93 cm.	 Bianco <i>White</i>  Teak <i>Teak</i>
	Art. 09012 Art. 09013	Pensile sopra cappa, apertura a 2 ante. <i>Overhead stove ventilation hood, with two opening doors.</i>	60 x 33 x h.40 cm.	 Bianco <i>White</i>  Teak <i>Teak</i>		Art. 09018 Art. 09019	Base con tre cassetti. <i>Base with three drawers.</i>	40 x 50 x h.93 cm.	 Bianco <i>White</i>  Teak <i>Teak</i>
	Art. 09014 Art. 09015	Pensile sopra cappa, apertura a 2 ante. <i>Overhead stove ventilation hood, with two opening doors.</i>	80 x 33 x h.40 cm.	 Bianco <i>White</i>  Teak <i>Teak</i>		Art. 09020 Art. 09021	Base con due ante. <i>Base with two doors.</i>	80 x 50 x h.93 cm.	 Bianco <i>White</i>  Teak <i>Teak</i>

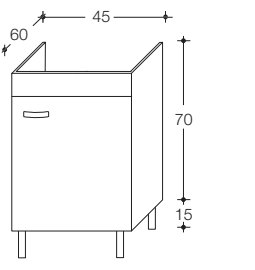

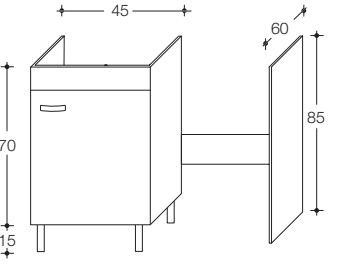

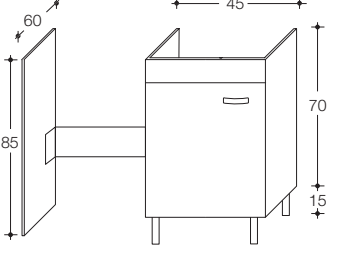



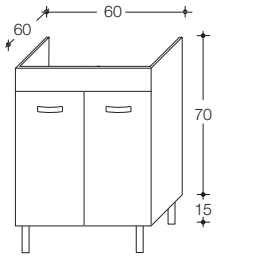
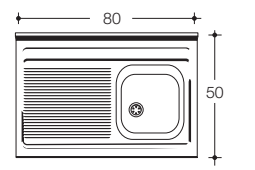
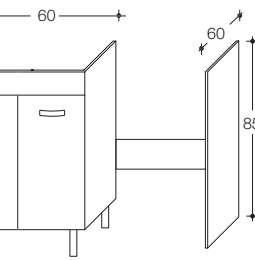
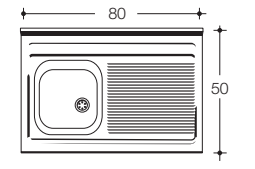
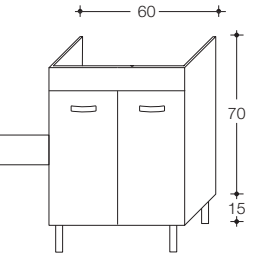
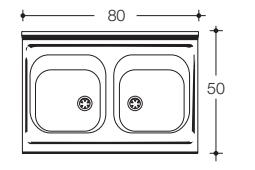
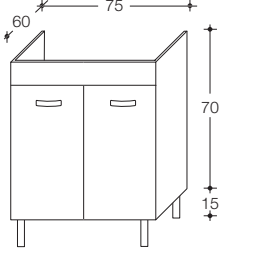
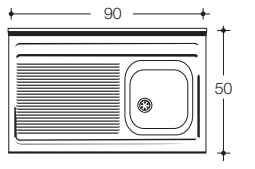
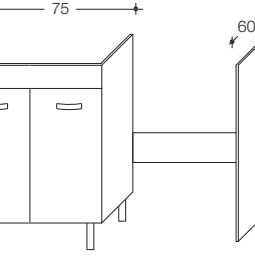
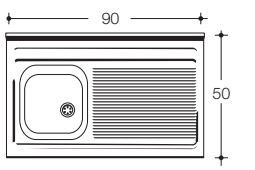
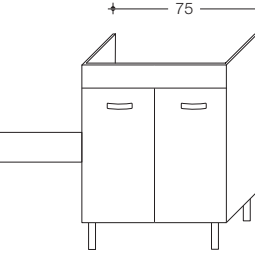
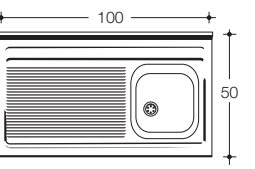
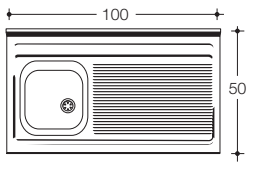
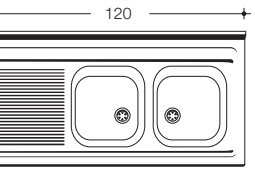
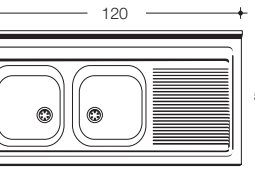

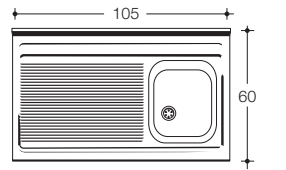
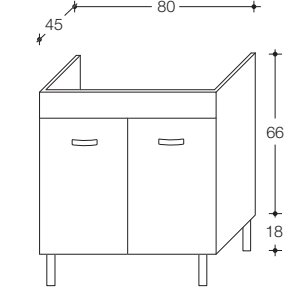

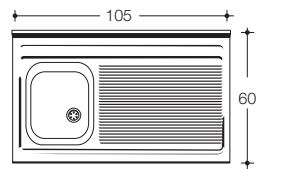
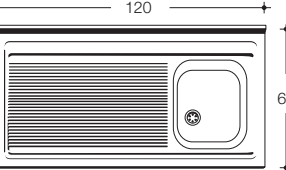
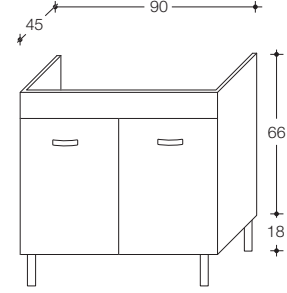

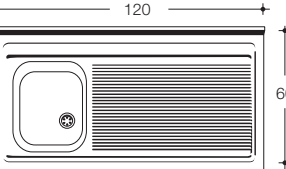
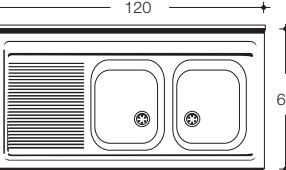
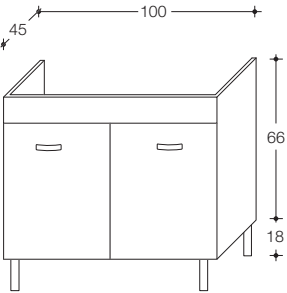
ELEMENTO / ELEMENT	CODICE / CODE	DESCRIZIONE / DESCRIPTION	MISURE / DIMENSIONS	FINITURE ANTE / DOORS FINISH	ELEMENTO / ELEMENT	CODICE / CODE	DESCRIZIONE / DESCRIPTION	MISURE / DIMENSIONS	FINITURE ANTE / DOORS FINISH
	Art. 01050/D Art. 01051/D	Sottolavello fisso a 2 ante completo di lavello in acciaio inox a vasca destra. <i>Fixed under-sink bench with two doors, complete with single right stainless steel sink.</i>	80 x 50 x h.93 cm.	 Bianco <i>White</i>  Teak <i>Teak</i>		Art. 01052/S Art. 01053/S	Sottolavello fisso a 2 ante completo di lavello in acciaio inox a vasca sinistra. <i>Fixed under-sink bench with two doors, complete with single left stainless steel sink.</i>	90 x 50 x h.93 cm.	 Bianco <i>White</i>  Teak <i>Teak</i>
	Art. 01050/S Art. 01051/S	Sottolavello fisso a 2 ante completo di lavello in acciaio inox a vasca sinistra. <i>Fixed under-sink bench with two doors, complete with single left stainless steel sink.</i>	80 x 50 x h.93 cm.	 Bianco <i>White</i>  Teak <i>Teak</i>		Art. 01054/D Art. 01055/D	Sottolavello fisso a 2 ante completo di lavello in acciaio inox a vasca destra. <i>Fixed under-sink bench with two doors, complete with single right stainless steel sink.</i>	100 x 50 x h.93 cm.	 Bianco <i>White</i>  Teak <i>Teak</i>
	Art. 01058 Art. 01059	Sottolavello fisso a 2 ante completo di lavello in acciaio inox con 2 vasche. <i>Fixed under-sink bench with two doors, complete with double stainless steel sink.</i>	80 x 50 x h.93 cm.	 Bianco <i>White</i>  Teak <i>Teak</i>		Art. 01054/S Art. 01055/S	Sottolavello fisso a 2 ante completo di lavello in acciaio inox a vasca sinistra. <i>Fixed under-sink bench with two doors, complete with single left stainless steel sink.</i>	100 x 50 x h.93 cm.	 Bianco <i>White</i>  Teak <i>Teak</i>
	Art. 01064/D Art. 01065/D	Sottolavello fisso con anta singola e tre cassetti laterali completo di lavello in acciaio inox a vasca destra. <i>Fixed under-sink bench with single door and three lateral drawers, complete with single right stainless steel sink.</i>	80 x 50 x h.93 cm.	 Bianco <i>White</i>  Teak <i>Teak</i>		Art. 01056/D Art. 01057/D	Sottolavello fisso a 3 ante completo di lavello in acciaio inox con 2 vasche destre. <i>Fixed under-sink bench with three doors, complete with double right stainless steel sink.</i>	120 x 50 x h.93 cm.	 Bianco <i>White</i>  Teak <i>Teak</i>
	Art. 01064/S Art. 01065/S	Sottolavello fisso con anta singola e tre cassetti completo di lavello in acciaio inox a vasca sinistra. <i>Fixed under-sink bench with single door and three lateral drawers, complete with single left stainless steel sink.</i>	80 x 50 x h.93 cm.	 Bianco <i>White</i>  Teak <i>Teak</i>		Art. 01056/S Art. 01057/S	Sottolavello fisso a 3 ante completo di lavello in acciaio inox con 2 vasche sinistre. <i>Fixed under-sink bench with three doors, complete with double left stainless steel sink.</i>	120 x 50 x h.93 cm.	 Bianco <i>White</i>  Teak <i>Teak</i>
	Art. 01052/D Art. 01053/D	Sottolavello fisso a 2 ante completo di lavello in acciaio inox a vasca destra. <i>Fixed under-sink bench with two doors, complete with single right stainless steel sink.</i>	90 x 50 x h.93 cm.	 Bianco <i>White</i>  Teak <i>Teak</i>		Art. 01066/D Art. 01067/D	Sottolavello fisso a 2 ante e tre cassetti completo di lavello in acciaio inox con 2 vasche destre. <i>Fixed under-sink bench with three doors and three lateral drawers, complete with double right stainless steel sink.</i>	120 x 50 x h.93 cm.	 Bianco <i>White</i>  Teak <i>Teak</i>

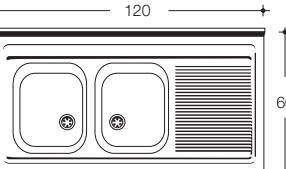
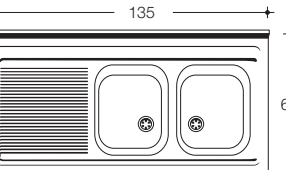
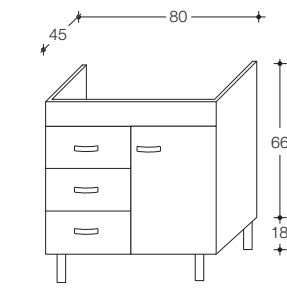
ELEMENTO / ELEMENT	CODICE / CODE	DESCRIZIONE / DESCRIPTION	MISURE / DIMENSIONS	FINITURE ANTE / DOORS FINISH	ELEMENTO / ELEMENT	CODICE / CODE	DESCRIZIONE / DESCRIPTION	MISURE / DIMENSIONS	FINITURE ANTE / DOORS FINISH
	Art. 01066/S Art. 01067/S	Sottolavello fisso a 2 ante e tre cassetti completo di lavello in acciaio inox con 2 vasche sinistre. <i>Fixed under-sink bench with three doors and three lateral drawers, complete with double left stainless steel sink.</i>	120 x 50 x h.93 cm.	 Bianco White  Teak Teak		Art. 03070 Art. 03071	Sottolavello a 2 ante fisso per lavello in acciaio inox. <i>Fixed under-sink bench with two doors, fixed structure, for stainless steel.</i>	80 x 50 x h.84 cm.	 Bianco White  Teak Teak
	Art. 01060/D Art. 01061/D	Sottolavello fisso a 3 ante completo di lavello in acciaio inox con 2 vasche destre. <i>Fixed under-sink bench with fixed structure with three doors, complete with double right stainless steel sink.</i>	120 x 60 x h.93 cm.	 Bianco White  Teak Teak		Art. 03088/D Art. 03089/D Art. 03088/S Art. 03089/S	Sottolavello con anta singola e 3 cassetti laterali, per lavello in acciaio inox. <i>Under-sink bench with single door and three lateral drawers for stainless steel sinks.</i>  Le lettere "D" e "S" si riferiscono rispettivamente al posizionamento dx o sx dei cassetti. <i>The letters "D" and "S" refer respectively to the right or left positioning of the drawers.</i>	80 x 50 x h.84 cm.	 Bianco White  Teak Teak  Bianco White  Teak Teak
	Art. 01060/S Art. 01061/S	Sottolavello fisso a 3 ante completo di lavello in acciaio inox con 2 vasche sinistre. <i>Fixed under-sink bench with fixed structure with three doors, complete with double left stainless steel sink.</i>	120 x 60 x h.93 cm.	 Bianco White  Teak Teak		Art. 03072 Art. 03073	Sottolavello a 2 ante fisso per lavello in acciaio inox. <i>Fixed under-sink bench with two doors, fixed structure, for stainless steel sinks.</i>	90 x 50 x h.84 cm.	 Bianco White  Teak Teak
	Art. 01062/D Art. 01063/D	Sottolavello fisso a 3 ante completo di lavello in acciaio inox con 2 vasche destre. <i>Fixed under-sink bench with fixed structure with three doors, complete with double right stainless steel sink.</i>	135 x 60 x h.93 cm.	 Bianco White  Teak Teak		Art. 03074 Art. 03075	Sottolavello a 2 ante fisso per lavello in acciaio inox. <i>Fixed under-sink bench with two doors, fixed structure for stainless steel sinks.</i>	100 x 50 x h.84 cm.	 Bianco White  Teak Teak
	Art. 01062/S Art. 01063/S	Sottolavello fisso a 3 ante completo di lavello in acciaio inox con 2 vasche sinistre. <i>Fixed under-sink bench with fixed structure with three doors, complete with double left stainless steel sink.</i>	135 x 60 x h.93 cm.	 Bianco White  Teak Teak					

ELEMENTO / ELEMENT	CODICE / CODE	DESCRIZIONE / DESCRIPTION	MISURE / DIMENSIONS	FINITURE ANTE / DOORS FINISH	ELEMENTO / ELEMENT	CODICE / CODE	DESCRIZIONE / DESCRIPTION	MISURE / DIMENSIONS	FINITURE ANTE / DOORS FINISH
	<b>Art. 03076</b> <b>Art. 03077</b>	Sottolavello a 3 ante fisso, per lavello in acciaio inox. <i>Fixed under-sink bench with three doors, fixed structure for stainless steel sinks.</i>	<b>120 x 50 x h.84 cm.</b>	 Bianco <i>White</i>  Teak <i>Teak</i>		<b>Art. 03082</b> <b>Art. 03083</b>	Sottolavello a 2 ante pieghevole, con struttura in alluminio a plega nascosta, per lavello in acciaio inox. <i>Under-sink bench with two doors and folding structure, for stainless steel sink.</i>	<b>90 x 50 x h.66 cm.</b>	 Bianco <i>White</i>  Teak <i>Teak</i>
	<b>Art. 03090/D</b> <b>Art. 03091/D</b> <b>Art. 03090/S</b> <b>Art. 03091/S</b>	Sottolavello a 2 ante e tre cassetti per lavello in acciaio inox. <i>Under-sink bench with single door and three lateral drawers for stainless steel sinks.</i> Le lettere "D" e "S" si riferiscono rispettivamente al posizionamento dx o sx dei cassetti. <i>The letters "D" and "S" refer respectively to the right or left positioning of the drawers.</i>	<b>120 x 50 x h.84 cm.</b>	 Bianco <i>White</i>  Teak <i>Teak</i>  Bianco <i>White</i>  Teak <i>Teak</i>		<b>Art. 03084</b> <b>Art. 03085</b>	Sottolavello a 2 ante pieghevole, con struttura in alluminio a plega nascosta, per lavello in acciaio inox. <i>Under-sink bench with two doors and folding structure, complete for stainless steel sink.</i>	<b>100 x 50 x h.66 cm.</b>	 Bianco <i>White</i>  Teak <i>Teak</i>
	<b>Art. 03092</b> <b>Art. 03093</b>	Sottolavello a 3 ante fisso per lavello in acciaio inox. <i>Fixed under-sink bench with three doors, with fixed structure for stainless steel sinks.</i>	<b>120 x 60 x h.84 cm.</b>	 Bianco <i>White</i>  Teak <i>Teak</i>		<b>Art. 03086</b> <b>Art. 03087</b>	Sottolavello a 3 ante pieghevole, con struttura in alluminio a plega nascosta, per lavello in acciaio inox. <i>Under-sink bench with three doors and folding structure, for stainless steel sink.</i>	<b>120 x 50 x h.66 cm.</b>	 Bianco <i>White</i>  Teak <i>Teak</i>
	<b>Art. 03094</b> <b>Art. 03095</b>	Sottolavello a 3 ante fisso per lavello in acciaio inox. <i>Fixed under-sink bench with three doors, with fixed structure for stainless steel sinks.</i>	<b>135 x 60 x h.84 cm.</b>	 Bianco <i>White</i>  Teak <i>Teak</i>	<b>Sottolavelli per inserimento lavastoviglie</b> <i>Under-sink bench prepared for dishwashers</i>				

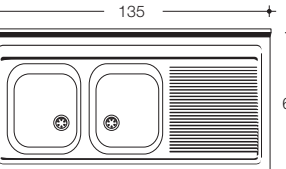
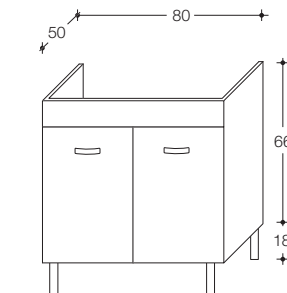

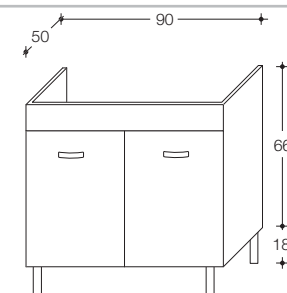







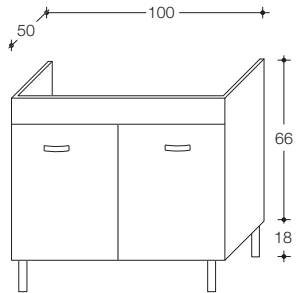

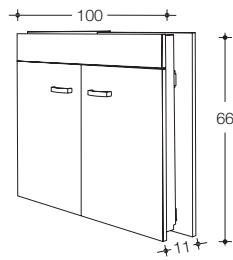
ELEMENTO / ELEMENT	CODICE / CODE	DESCRIZIONE / DESCRIPTION	MISURE / DIMENSIONS	FINITURE ANTE / DOORS FINISH	ELEMENTO / ELEMENT	CODICE / CODE	DESCRIZIONE / DESCRIPTION	MISURE / DIMENSIONS	FINITURE ANTE / DOORS FINISH
	<b>Art. 03080</b> <b>Art. 03081</b>	Sottolavello a 2 ante pieghevole, con struttura in alluminio a plega nascosta, per lavello in acciaio inox. <i>Under-sink bench with two doors and folding structure, for stainless steel sink.</i>	<b>80 x 50 x h.66 cm.</b>	 Bianco <i>White</i>  Teak <i>Teak</i>		<b>Art. 03100</b> <b>Art. 03101</b>	Sottolavello per lavastoviglie senza 3° fianco apertura lato destro. <i>Under-sink bench for dishwashers without third right side with right side opening.</i>	<b>45 x 60 x h.85 cm.</b>	 Bianco <i>White</i>  Teak <i>Teak</i>
						<b>Art. 03106/D</b> <b>Art. 03107/D</b>	Sottolavello per lavastoviglie con 3° fianco destro apertura lato destro. <i>Under-sink bench for dishwashers with third right side with right side opening.</i>	<b>45 x 60 x h. 85 cm.</b>	 Bianco <i>White</i>  Teak <i>Teak</i>
						<b>Art. 03106/S</b> <b>Art. 03107/S</b>	Sottolavello per lavastoviglie con 3° fianco sinistro apertura lato sinistro. <i>Under-sink bench for dishwashers with third left side with left side opening.</i>	<b>45 x 60 x h. 85 cm.</b>	 Bianco <i>White</i>  Teak <i>Teak</i>

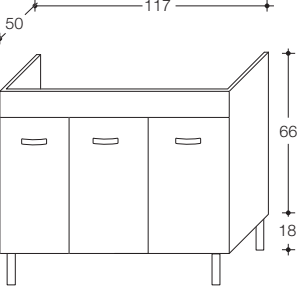

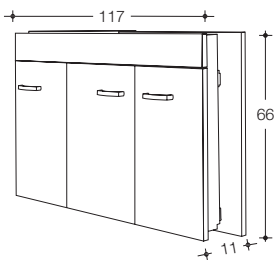

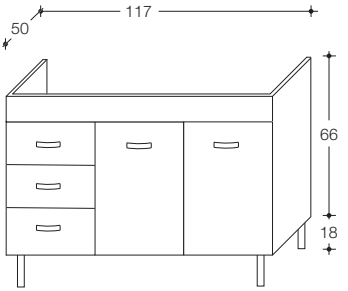





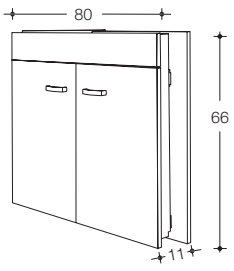

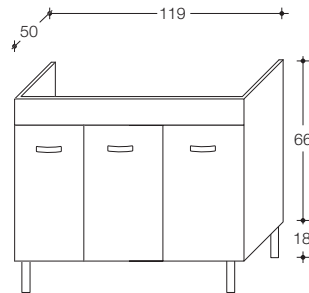
ELEMENTO / ELEMENT	CODICE / CODE	DESCRIZIONE / DESCRIPTION	MISURE / DIMENSIONS	FINITURE ANTE / DOORS FINISH	ELEMENTO / ELEMENT	CODICE / CODE	DESCRIZIONE / DESCRIPTION	MISURE / DIMENSIONS	FINITURE ANTE / DOORS FINISH
	Art. 03102 Art. 03103	Sottolavello per lavastoviglie senza 3° fianco. <i>Under-sink bench for dishwashers without third right side.</i>	60 x 60 x h.85 cm.	Bianco <i>White</i> Teak <i>Teak</i>		Art. 04000/D	Lavello in acciaio inox ad una vasca destra. <i>Single stainless steel right sink.</i>	80 x 50 x h.3 cm.	
	Art. 03108/D Art. 03109/D	Sottolavello per lavastoviglie con 3° fianco destro. <i>Under-sink bench for dishwashers with third right side.</i>	60 x 60 x h. 85 cm.	Bianco <i>White</i> Teak <i>Teak</i>		Art. 04000/S	Lavello in acciaio inox ad una vasca sinistra. <i>Single stainless steel left sink.</i>	80 x 50 x h.3 cm.	
	Art. 03108/S Art. 03109/S	Sottolavello per lavastoviglie con 3° fianco sinistro. <i>Under-sink bench for dishwashers with third left side.</i>	60 x 60 x h. 85 cm.	Bianco <i>White</i> Teak <i>Teak</i>		Art. 04004	Lavello in acciaio inox a due vasche. <i>Double stainless steel sink.</i>	80 x 50 x h.3 cm.	
	Art. 03104 Art. 03105	Sottolavello per lavastoviglie senza 3° fianco. <i>Under-sink bench for dishwashers without third right side.</i>	75 x 60 x h. 85 cm.	Bianco <i>White</i> Teak <i>Teak</i>		Art. 04001/D	Lavello in acciaio inox ad una vasca destra. <i>Single stainless steel right sink.</i>	90 x 50 x h.3 cm.	
	Art. 03110/D Art. 03111/D	Sottolavello per lavastoviglie con 3° fianco destro. <i>Under-sink bench for dishwashers with third right side.</i>	75 x 60 x h. 85 cm.	Bianco <i>White</i> Teak <i>Teak</i>		Art. 04001/S	Lavello in acciaio inox ad una vasca, sinistra. <i>Single stainless steel left sink.</i>	90 x 50 x h.3 cm.	
	Art. 03110/S Art. 03111/S	Sottolavello per lavastoviglie con 3° fianco sinistro. <i>Under-sink bench for dishwashers with third left side.</i>	75 x 60 x h. 85 cm.	Bianco <i>White</i> Teak <i>Teak</i>		Art. 04002/D	Lavello in acciaio inox ad una vasca destra. <i>Single stainless steel right sink.</i>	100 x 50 x h.3 cm.	
						Art. 04002/S	Lavello in acciaio inox ad una vasca, sinistra. <i>Single stainless steel left sink.</i>	100 x 50 x h.3 cm.	
						Art. 04003/D	Lavello in acciaio inox a due vasche destre. <i>Double right stainless steel sink.</i>	120 x 50 x h.3 cm.	
						Art. 04003/S	Lavello in acciaio inox a due vasche sinistre. <i>Double left stainless steel sink.</i>	120 x 50 x h.3 cm.	

ELEMENTO / ELEMENT	CODICE / CODE	DESCRIZIONE / DESCRIPTION	MISURE / DIMENSIONS	FINITURE ANTE / DOORS FINISH	ELEMENTO / ELEMENT	CODICE / CODE	DESCRIZIONE / DESCRIPTION	MISURE / DIMENSIONS	FINITURE ANTE / DOORS FINISH
	<b>Art. 04009/D</b>	Lavello in acciaio inox ad una vasca destra. <i>Single stainless steel right or left sink.</i>	<b>105 x 60 x h.3 cm.</b>			<b>Art. 02060</b> <b>Art. 02061</b>	Sottolavello a 2 ante con struttura fissa per lavello in ceramica. <i>Under-sink bench with two doors, fixed structure, for ceramic sinks.</i>	<b>80 x 45 x h. 84 cm.</b>	 Bianco <i>White</i>  Teak <i>Teak</i>
	<b>Art. 04009/S</b>	Lavello in acciaio inox ad una vasca sinistra. <i>Single stainless steel left sink.</i>	<b>105 x 60 x h.3 cm.</b>						
	<b>Art. 04010/D</b>	Lavello in acciaio inox ad una vasca destra. <i>Single stainless steel right sink.</i>	<b>120 x 60 x h.3 cm.</b>			<b>Art. 02062</b> <b>Art. 02063</b>	Sottolavello a 2 ante con struttura fissa per lavello in ceramica. <i>Under-sink bench with two doors, fixed structure, for ceramic sinks.</i>	<b>90 x 45 x h. 84 cm.</b>	 Bianco <i>White</i>  Teak <i>Teak</i>
	<b>Art. 04010/S</b>	Lavello in acciaio inox ad una vasca sinistra. <i>Single stainless steel left sink.</i>	<b>120 x 60 x h.3 cm.</b>						
	<b>Art. 04012/D</b>	Lavello in acciaio inox a due vasche destre. <i>Double right stainless steel sink.</i>	<b>120 x 60 x h.3 cm.</b>			<b>Art. 02064</b> <b>Art. 02065</b>	Sottolavello a 2 ante con struttura fissa per lavello in ceramica. <i>Under-sink bench with two doors, fixed structure, for ceramic sinks.</i>	<b>100 x 45 x h. 84 cm.</b>	 Bianco <i>White</i>  Teak <i>Teak</i>
	<b>Art. 04012/S</b>	Lavello in acciaio inox a due vasche sinistre. <i>Double left stainless steel sink.</i>	<b>120 x 60 x h.3 cm.</b>						
	<b>Art. 04011/D</b>	Lavello in acciaio inox a due vasche destre. <i>Double right stainless steel sink.</i>	<b>135 x 60 x h.3 cm.</b>			<b>Art. 02092/D</b> <b>Art. 02092/S</b> <b>Art. 02093/D</b> <b>Art. 02093/S</b>	Sottolavello con anta singola e 3 cassetti laterali per lavello in ceramica. <i>Under-sink bench with single door and three lateral drawers, for ceramic sinks.</i> Le lettere "D" e "S" si riferiscono rispettivamente al posizionamento dx o sx dei cassetti <i>The letters "D" and "S" refer respectively to the right or left positioning of the drawers.</i>	<b>80 x 45 x h.84 cm.</b>	 Bianco <i>White</i>  Bianco <i>White</i>  Teak <i>Teak</i>  Teak <i>Teak</i>
	<b>Art. 04011/S</b>	Lavello in acciaio inox a due vasche sinistre. <i>Double left stainless steel sink.</i>	<b>135 x 60 x h.3 cm.</b>			<b>Art. 02068</b> <b>Art. 02069</b>	Sottolavello a 2 ante con struttura fissa per lavello in ceramica. <i>Under-sink bench with two doors, fixed structure, for ceramic sinks.</i>	<b>80 x 50 x h. 84 cm.</b>	 Bianco <i>White</i>  Teak <i>Teak</i>
						<b>Art. 02070</b> <b>Art. 02071</b>	Sottolavello a 2 ante con struttura fissa per lavello in ceramica. <i>Under-sink bench with two doors, fixed structure, for ceramic sinks.</i>	<b>90 x 50 x h. 84 cm.</b>	 Bianco <i>White</i>  Teak <i>Teak</i>

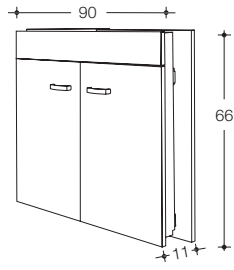
Realizzati in acciaio Inox 18/10 sono forniti completi di sifone, piletta e troppo pieno, oltre al tappo copriforo per eventuale predisposizione delle rubinetterie a muro.

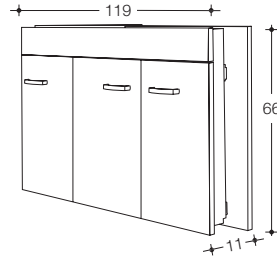
*Realised in stainless steel 18/10 and supplied complete with siphon, drain connection and overflow, as well as the hole cover for eventual preparation of wall-mounted fittings.*











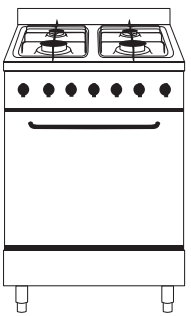

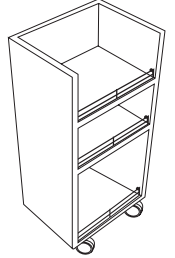

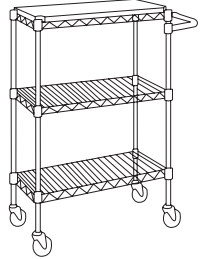

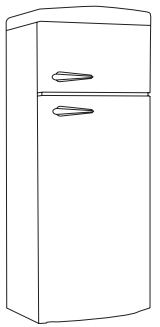

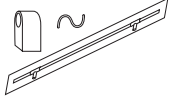

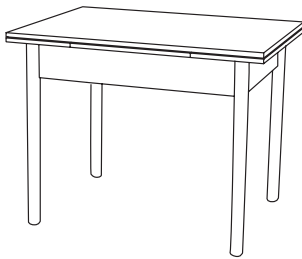

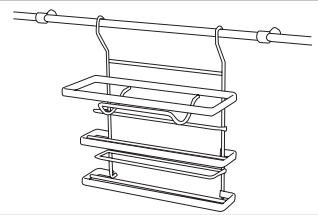



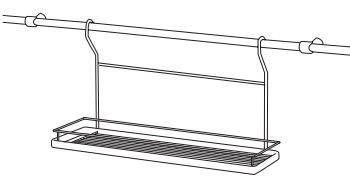

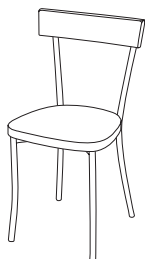
ELEMENTO / ELEMENT	CODICE / CODE	DESCRIZIONE / DESCRIPTION	MISURE / DIMENSIONS	FINITURE ANTE / DOORS FINISH	ELEMENTO / ELEMENT	CODICE / CODE	DESCRIZIONE / DESCRIPTION	MISURE / DIMENSIONS	FINITURE ANTE / DOORS FINISH	
	<b>Art. 02072</b> <b>Art. 02073</b>	Sottolavello a 2 ante con struttura fissa per lavello in ceramica. <i>Under-sink bench with two doors, fixed structure, for ceramic sinks.</i>	<b>100 x 50 x h.84 cm.</b>	 Bianco <i>White</i>  Teak <i>Teak</i>		<b>Art. 02084</b> <b>Art. 02085</b>	Sottolavello a 2 ante pieghevole con struttura in alluminio a piega nascosta per lavello in ceramica. <i>Under-sink bench with two doors and folding structure, for ceramic sink.</i>	<b>100 x 45 x h.66 cm.</b>	 Bianco <i>White</i>  Teak <i>Teak</i>	
	<b>Art. 02066</b> <b>Art. 02067</b>	Sottolavello a 3 ante con struttura fissa per lavello in ceramica. <i>Under-sink bench with two doors, fixed structure, for ceramic sinks.</i>	<b>117 x 50 x h. 84 cm.</b>	 Bianco <i>White</i>  Teak <i>Teak</i>		<b>Art. 02086</b> <b>Art. 02087</b>	Sottolavello a 3 ante pieghevole con struttura in alluminio a piega nascosta per lavello in ceramica. <i>Under-sink bench with three doors and folding structure, for ceramic sink.</i>	<b>117 x 50 x h.66 cm.</b>	 Bianco <i>White</i>  Teak <i>Teak</i>	
	<b>Art. 02094/D</b> <b>Art. 02094/S</b> <b>Art. 02095/D</b> <b>Art. 02095/S</b>	Sottolavello con 2 ante e tre cassetti laterali per lavello in ceramica. <i>Under-sink bench with two door and three lateral drawers, for ceramic sinks.</i> Le lettere "D" e "S" si riferiscono rispettivamente al posizionamento dx o sx dei cassetti <i>The letters "D" and "S" refer respectively to the right or left positioning of the drawers.</i>	<b>117 x 50 x h.84 cm.</b>	 Bianco <i>White</i>  Teak <i>Teak</i>  Bianco <i>White</i>  Teak <i>Teak</i>	<b>Sottolavelli e pieghevoli predisposti per lavello in ceramica "GALASSIA"</b> <i>Under sink and cabinets with folding structure prepared for "GALASSIA" ceramic sink</i>					<b>Cucina "SOFIA"</b>

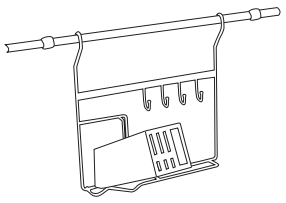

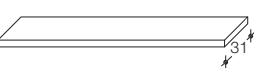

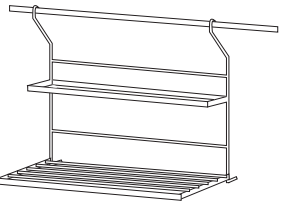

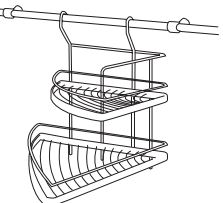
ELEMENTO / ELEMENT	CODICE / CODE	DESCRIZIONE / DESCRIPTION	MISURE / DIMENSIONS	FINITURE ANTE / DOORS FINISH	ELEMENTO / ELEMENT	CODICE / CODE	DESCRIZIONE / DESCRIPTION	MISURE / DIMENSIONS	FINITURE ANTE / DOORS FINISH
	<b>Art. 02080</b> <b>Art. 02081</b>	Sottolavello a 2 ante pieghevole con struttura in alluminio a piega nascosta per lavello in ceramica. <i>Under-sink bench with two doors and folding structure, for ceramic sink.</i>	<b>80 x 45 x h.66 cm.</b>	 Bianco <i>White</i>  Teak <i>Teak</i>		<b>Art. 02088/D</b> <b>Art. 02088/S</b> <b>Art. 02089/D</b> <b>Art. 02089/S</b>	Sottolavello a 3 ante con struttura fissa, per lavello in ceramica "Galassia". <i>Under-sink bench with three doors, fixed structure, for "Galassia" ceramic sinks.</i> Le lettere "D" e "S" si riferiscono rispettivamente al posizionamento dx o sx della vasca del lavello in ceramica <i>The letters "D" and "S" refer respectively to the right or left positioning of the ceramic sink</i>	<b>119 x 50 x h.84 cm.</b>	 Bianco <i>White</i>  Bianco <i>White</i>  Teak <i>Teak</i>  Teak <i>Teak</i>
	<b>Art. 02082</b> <b>Art. 02083</b>	Sottolavello a 2 ante pieghevole con struttura in alluminio a piega nascosta per lavello in ceramica. <i>Under-sink bench with two doors and folding structure, for ceramic sink.</i>	<b>90 x 45 x h.66 cm.</b>	 Bianco <i>White</i>  Teak <i>Teak</i>		<b>Art. 02090/D</b> <b>Art. 02090/S</b> <b>Art. 02091/D</b> <b>Art. 02091/S</b>	Sottolavello a 3 ante con struttura pieghevole in alluminio a piega nascosta per lavello in ceramica "Galassia". <i>Under-sink bench with three doors and folding structure, for "Galassia" ceramic sinks.</i> Le lettere "D" e "S" si riferiscono rispettivamente al posizionamento dx o sx della vasca del lavello in ceramica. <i>The letters "D" and "S" refer respectively to the right or left positioning of the ceramic sink.</i>	<b>119 x 50 x h.66 cm.</b>	 Bianco <i>White</i>  Bianco <i>White</i>  Teak <i>Teak</i>  Teak <i>Teak</i>

Per i modelli predisposti per i lavelli "Galassia" deve essere specificato, al momento dell'ordine, la versione dx o sx delle vasche.

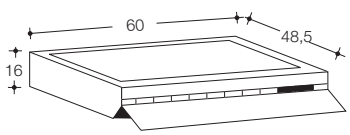
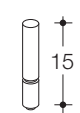
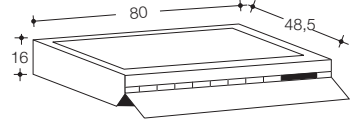
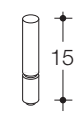
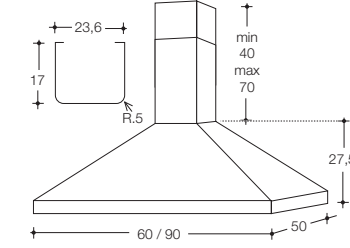
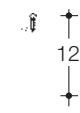
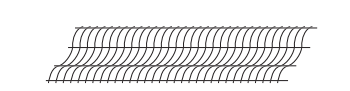
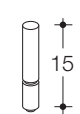
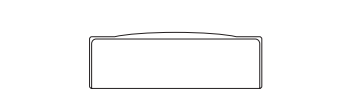
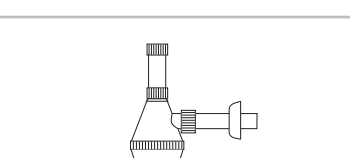
For models prepared for "Galassia", the right or left sink version must be specified at the time of ordering.

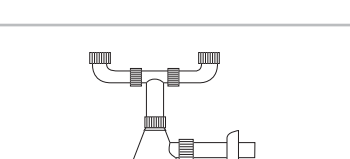
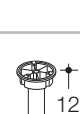
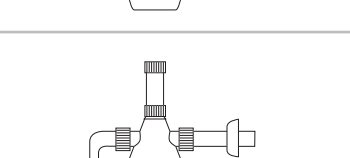

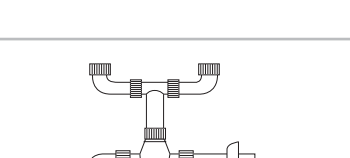
ELEMENTO / ELEMENT	CODICE / CODE	DESCRIZIONE / DESCRIPTION	MISURE / DIMENSIONS	FINITURE ANTE / DOORS FINISH	ELEMENTO / ELEMENT	CODICE / CODE	DESCRIZIONE / DESCRIPTION	MISURE / DIMENSIONS	FINITURE ANTE / DOORS FINISH
	Art. 17000	Cucina appoggio "Yolly" in inox con quattro fuochi valvolati, accensione elettrica, forno elettrico statico quattro funzioni con girarrosto. <i>Inox cooking table "Yolly" with four cooking positions, electrical switch, electrical oven with four functions with spit.</i>  Piedini disponibili: h 12 cm, h 15 cm, h 18 cm <i>Available feet: h 12 cm, h 15 cm, h 18 cm</i>	60 x 50 x h.75 cm.	 Inox Inox		Art. 19070	Carrellino porta oggetti in legno con ruote. <i>Wooden trolley with wheels.</i>	25 x 32 x h. 71 cm.	 Ciliegio Cherry
	Art. 17007	Coperchio bilanciato in cristallo temperato specchio. <i>Mirror tempered glass cover.</i>	60 x 50 cm.			Art. 19071	Carrello portatutto e portabottiglie cromato a tre ripiani (il superiore in legno) con maniglia. <i>Chrome all-purpose and bottle-holder trolley, with handles and three levels, including one in wood.</i>	77 x 35 x h. 88 cm.	 Cromo Chrome
	Art. 17004/D Art. 17004/S	Frigorifero Nardi doppia porta retrò con apertura destra o sinistra. Capacità netta Frigo: 255 L Congelatore: 56 L Classe "A" <i>Refrigerator Nardi double doors with left and right open. Net capacity of Fridge: 255L Freezer: 56 L Class "A"</i>	L. 59,25 x P. 64,5 x h.171 cm.	 Silver Silver		Art. 19072	Kit tubo. Composto da tubo, due supporti, due terminali e quattro ganci a "S". <i>Pipe kit: consisting of pipe, two square supports, two end pieces and four "S" hooks.</i>	90 x diametro 1,6 cm.	 Cromo Chrome
	Art. 18013 Art. 18014	Tavolo allungabile in lunghezza. <i>Extendable length table.</i>	120 x 70 (All. 170 x 70) h.75 cm. 140 x 80 (All. 200 x 80) h.75 cm.	 Bianco White  Ciliegio Cherry		Art. 19073	Supporto porta rotolo carta cromato, a tre piani con seghetto taglia carta. <i>Chrome paper roll holder, three levels with paper cutter.</i>	32,5 x 15,5 x h. 40 cm.	 Cromo Chrome
	Art. 18015	Sedia in alluminio con seduta in paglia. <i>Aluminium chair with wicker seat.</i>		 Paglia Straw		Art. 19074	Supporto multifunzione cromato a un piano <i>Multi-function chrome support with one shelf</i>	45,5 x 18,5 x h. 27 cm.	 Cromo Chrome
	Art. 18016	Sedia in alluminio con seduta in ciliegio. <i>Aluminium chair with wicker cherry red.</i>		 Ciliegio Cherry		Art. 19075	Supporto portacoltelli cromato. <i>Chrome knife rack.</i>	35 x 23 x h. 35 cm.	 Cromo Chrome
	Art. 19078/B Art. 19078/C	Mensola a metro lineare. <i>Shelf by the linear metre.</i>	P. 31 cm. x Metro lineare	 Bianco White  Ciliegio Cherry		Art. 19076	Supporto per spezie cromato a due ripiani. <i>Chrome spice support with two shelves.</i>	35 x 17 x h. 27,5 cm.	 Cromo Chrome
						Art. 19077	Supporto cromato ad angolo a due ripiani. <i>Chrome corner support with two shelves.</i>	31,5 x 31,5 x h. 44 cm.	 Cromo Chrome

ELEMENTO / ELEMENT	CODICE / CODE	DESCRIZIONE / DESCRIPTION	MISURE / DIMENSIONS	FINITURE ANTE / DOORS FINISH	ELEMENTO / ELEMENTO	CODICE / CODE	DESCRIZIONE / DESCRIPTION	MISURE / DIMENSIONS	FINITURE ANTE / DOORS FINISH
	Art. 19008/B Art. 19008/N	Gruppo filtrante per cappa. <i>Filtering unit for hood.</i>	60 x 48,5 x h. 16 cm.	Bianco <i>White</i> Nero <i>Black</i>		Art. 19002/B Art. 19002/C	Piedino in finitura bianca per cucina "Marta". <i>Supporting foot in white finish for "Marta" kitchen.</i>	15 cm.	Bianco <i>White</i>
	Art. 19009/B Art. 19009/N	Gruppo filtrante per cappa. <i>Filtering unit for hood.</i>	80 x 48,5 x h. 16 cm.	Bianco <i>White</i> Nero <i>Black</i>		Art. 19002/C	Piedino in finitura ciliegio per cucina "Marta" in finitura Panna. <i>Supporting foot in cherry red finish for "Marta" kitchen in cream colour finish.</i>	15 cm.	Ciliegio <i>Cherry</i>
	Art. 19045 Art. 19046	Cappa camino filtrante in acciaio inox. <i>Stainless steel ventilation chute hood.</i>	60 x 50 x h.67,5/97,5 cm. 90 x 50 x h.67,5/97,5 cm.			Art. 19028/ALL.	Piedino in alluminio regolabile per cucina "Marta" in finitura rovere sbiancato. <i>Piedino in alluminio regolabile per cucina "Marta" in finitura rovere sbiancato.</i>	12 cm.	Alluminio <i>Aluminium</i>
	Art. 19004 Art. 19005	Griglia per scolapiatti completa. <i>Complete Dish draining rack.</i>	80 cm. 90 cm.			Art. 19002/B Art. 19002/N	Piedino in finitura bianca per sottolavello per lavastoviglie "Sofia". <i>Supporting foot in white finish for "Sofia" under-sink bench kitchen.</i> Piedino in finitura noce per sottolavello per lavastoviglie "Sofia". <i>Supporting foot in walnut finish for "Sofia" under-sink bench kitchen.</i>	15 cm.	Bianco <i>White</i> Noce <i>Walnut</i>
	Art. 19031 Art. 19032	Vaschetta raccogli-gocce neutra lunga con aletta. <i>Long neutral drip tray with lip.</i>	80 cm. 90 cm.						
	Art. 19033	Sifone completo a una via con piletta e troppo pieno. <i>Complete one-way siphon with drain and overflow.</i>				Art. 19027/B Art. 19027/N	Piedino in finitura bianca per cucina "Sofia". <i>Supporting foot in white finish for "Sofia" kitchen.</i> Piedino in finitura noce per cucina "Sofia". <i>Supporting foot in walnut finish for "Sofia" kitchen.</i>	18 cm.	Bianco <i>White</i> Noce <i>Walnut</i>
	Art. 19034	Sifone a due vie con piletta e troppo pieno. <i>Complete one-way siphon with drain and overflow.</i>				Art. 19030	Piedino per zoccolatura per cucina "Marta". <i>Foot for kickboard for "Marta" kitchen.</i>	12 cm.	Nero <i>Black</i>
	Art. 19035	Sifone ad una via per lavastoviglie con piletta e troppo pieno. <i>Complete one-way siphon with drain and overflow.</i>				Art. 19029/B Art. 19029/C Art. 19029/ALL	Zoccolatura per cucina "Marta". <i>kickboard for "Marta" kitchen.</i>	h. 12 cm.	Bianco <i>White</i> Ciliegio <i>Cherry</i> Alluminio <i>Aluminium</i>
	Art. 19036	Sifone a due vie per lavastoviglie con piletta e troppo pieno. <i>Complete two-way siphon for dishwashers with drain and overflow.</i>				Art. 19040	Maniglia alluminio per cucine "Marta" e "Sofia". <i>Aluminium furniture handle for "Marta" and "Sofia" kitchen.</i>	9,50 x h. 1,7 cm.	Alluminio <i>Aluminium</i>





LMC s.r.l. - Lavorazione Mobili Componibili  
Via Flaminia Km. 57,500 - 01033 Civita Castellana (VT)  
Tel. 0761.54.00.75/6 - Fax 0761.54.00.76

*web site: [www.ellemmeci.com](http://www.ellemmeci.com) - email: [info@ellemmeci.com](mailto:info@ellemmeci.com)*